



RHEINZINK America, Inc.

FLAT LOCK PANEL ROOF DETAILS

- DIAMOND
- RECTANGULAR
- SQUARE

INDEX OF DRAWINGS

- FLRP-1 - EAVE DETAIL
- FLRP-2 - BUILT-IN GUTTER DETAIL
- FLRP-3A - RIDGE / HIP DETAIL - OPTION 1
- FLRP-3B - RIDGE / HIP DETAIL - OPTION 2
- FLRP-4A - MONO-PITCH RIDGE DETAIL - OPTION 1
- FLRP-4B - MONO-PITCH RIDGE DETAIL - OPTION 2
- FLRP-5A - VALLEY DETAIL - OPTION 1
- FLRP-5B - VALLEY DETAIL - OPTION 2
- FLRP-6 - RAKE EDGE DETAIL
- FLRP-7 - CROSS JOINT DETAIL
- FLRP-8 - ROOF TO WALL TRANSITION DETAIL
- FLRP-9 - SIDEWALL DETAIL
- FLRP-10 - SKYLIGHT SILL DETAIL
- FLRP-11 - SKYLIGHT HEAD DETAIL
- FLRP-12 - SKYLIGHT JAMB DETAIL
- FLRP-13 - VENT PIPE PENETRATION DETAIL
- FLRP-14 - DIAMOND FABRICATION DETAIL
- FLRP-15A - RECTANGULAR FABRICATION DETAIL - HORIZONTAL
- FLRP-15B - RECTANGULAR FABRICATION DETAIL - VERTICAL
- FLRP-15C - RECTANGULAR FABRICATION DETAIL - HORIZONTAL FOLDED
- FLRP-15D - RECTANGULAR FABRICATION DETAIL - VERTICAL FOLDED
- FLRP-16 - SQUARE FABRICATION DETAIL

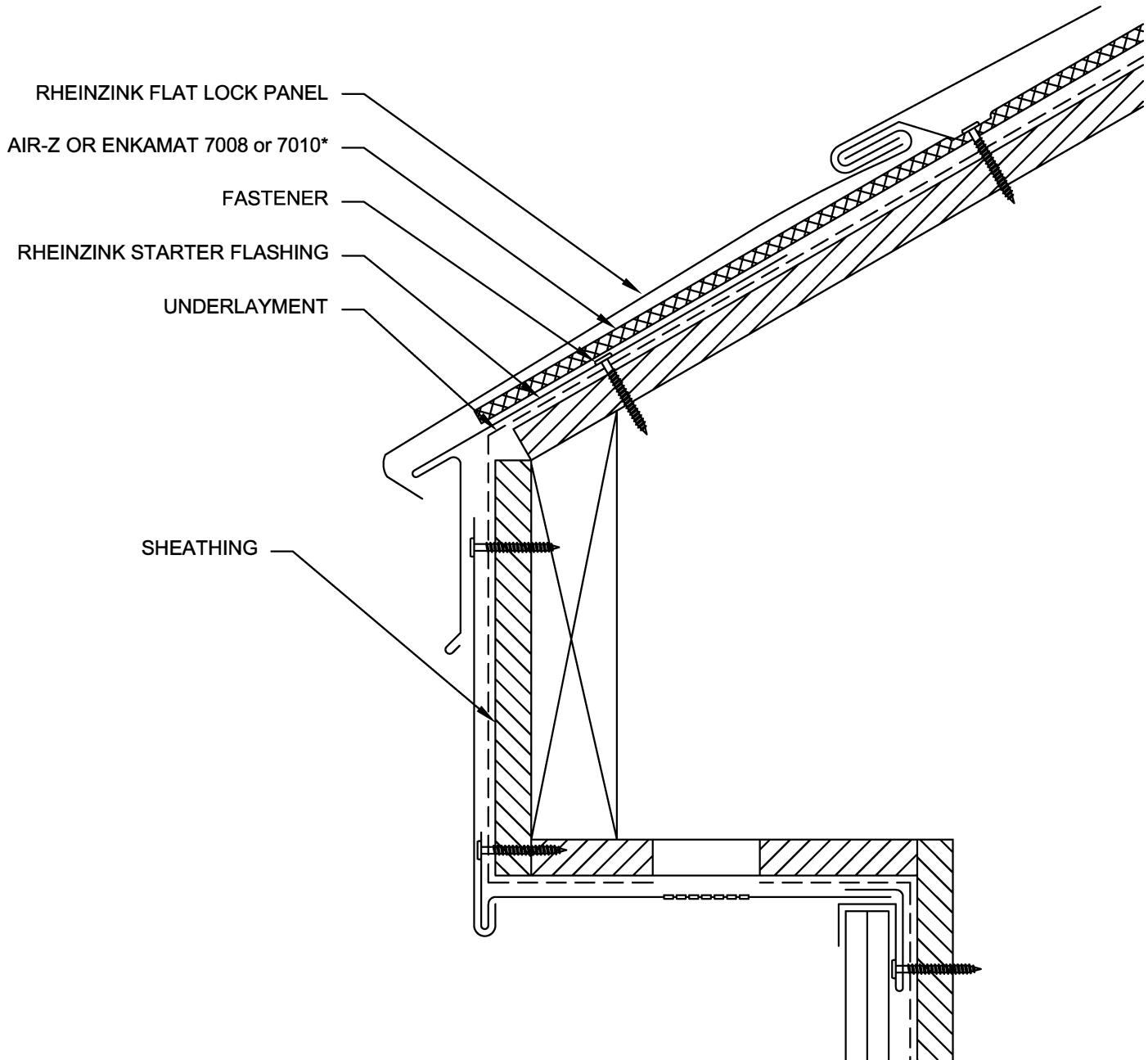

* CLIP DETAIL

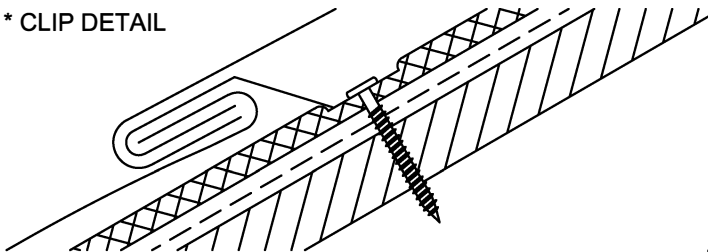

NOTES:

1. RHEINZINK RECOMMENDS STAINLESS STEEL FASTENERS AND CLIPS.
2. FLAT LOCK PANELS REQUIRE A MINIMUM OF 3:12 PITCH. FLAT LOCK PANEL ROOF SYSTEMS UP TO 6 IN 12 REQUIRE AIR-Z OR ENKAMAT (7008/7010) FLAT LOCK PANELS OVER A 6 IN 12 PITCH REQUIRE AIR-Z OR ENKAMAT (7008/7010).

| | | |
|--|-------------------------------------|----------------------|
|  Website: www.rheinzink.us E-mail: info@rheinzink.com | | |
| INFORMATION AND DETAILS HEREIN ARE ONLY A BASELINE FOR SYSTEM DESIGN AND INSTALLATION. MODIFICATION TO MEET PROJECT REQUIREMENTS IS THE RESPONSIBILITY OF THE DESIGNER AND ARCHITECT. RHEINZINK AMERICA STAFF ARE AVAILABLE TO ASSIST THE DESIGNER AND ARCHITECT IN THIS PROCESS. RHEINZINK AMERICA MAKES NO REPRESENTATIONS AND WARRANTIES OTHER THAN THOSE EXPRESSED HEREIN. | | |
| PROJECT: | FLAT LOCK ROOF PANEL DETAILS | DATE: 5-2020 |
| DRAWING TITLE: | EAVE DETAIL | SCALE: N.T.S. |
| COPYRIGHT RESERVED. THIS DRAWING REMAINS THE PROPERTY OF RHEINZINK. | | SHEET: FLRP-1 |

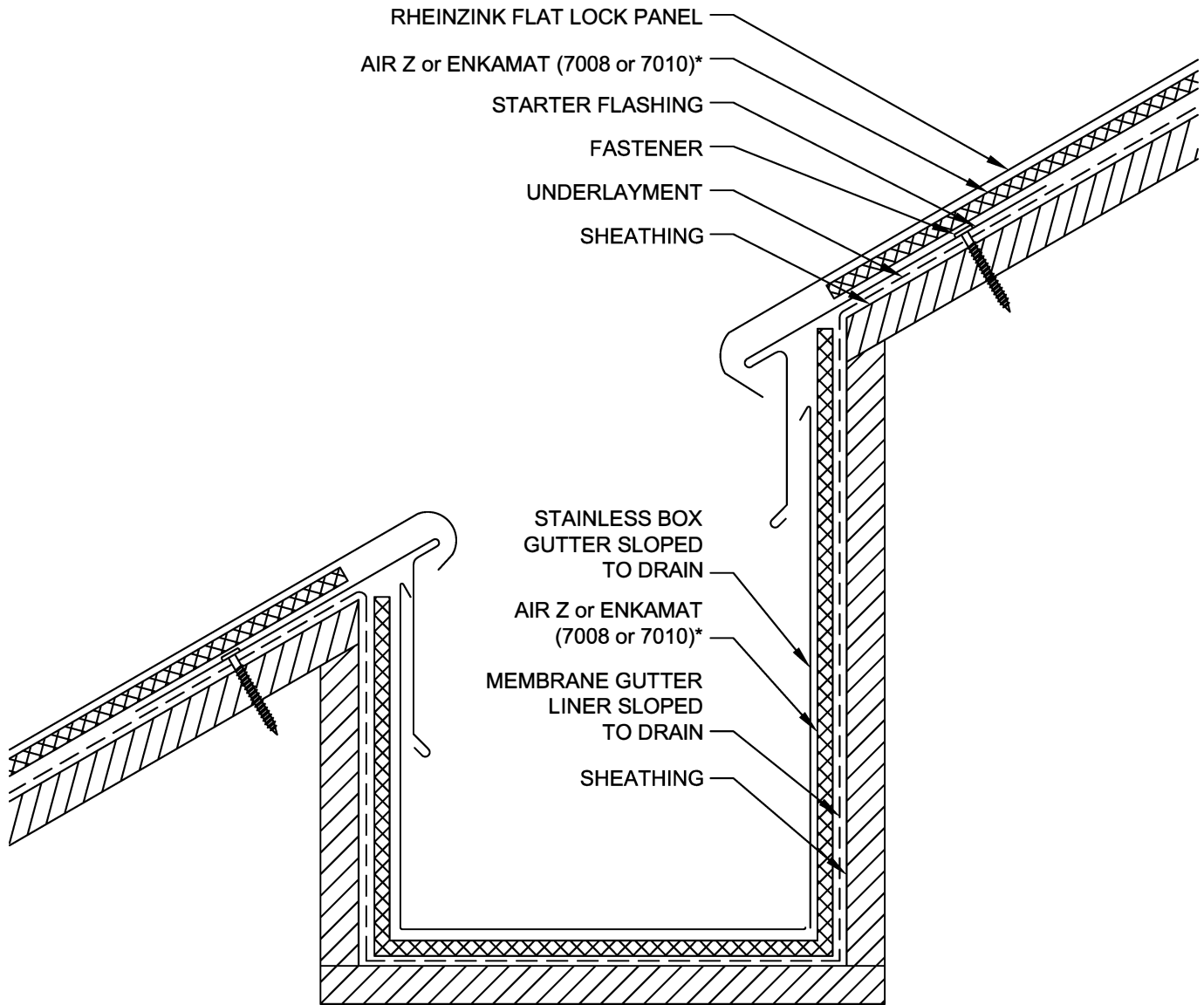

NOTES:

1. RHEINZINK RECOMMENDS STAINLESS STEEL FASTENERS AND CLIPS.
2. FLAT LOCK PANELS REQUIRE A MINIMUM OF 3:12 PITCH. FLAT LOCK PANEL ROOF SYSTEMS UP TO 6 IN 12 REQUIRE AIR-Z OR EN KAMAT (7008/7010) FLAT LOCK PANELS OVER A 6 IN 12 PITCH REQUIRE AIR-Z OR ENKAMAT (7008/7010).
- 3.



Website: www.rheinzink.us E-mail: info@rheinzink.com

INFORMATION AND DETAILS HEREIN ARE ONLY A BASELINE FOR SYSTEM DESIGN AND INSTALLATION. MODIFICATION TO MEET PROJECT REQUIREMENTS IS THE RESPONSIBILITY OF THE DESIGNER AND ARCHITECT. RHEINZINK AMERICA STAFF ARE AVAILABLE TO ASSIST THE DESIGNER AND ARCHITECT IN THIS PROCESS. RHEINZINK AMERICA MAKES NO REPRESENTATIONS AND WARRANTIES OTHER THAN THOSE EXPRESSED HEREIN.

| | | | |
|---|-------------------------------------|--------|---------------|
| PROJECT: | FLAT LOCK ROOF PANEL DETAILS | DATE: | 5-2020 |
| DRAWING TITLE: | BUILT-IN GUTTER DETAIL | SCALE: | N.T.S. |
| COPYRIGHT RESERVED. THIS DRAWING REMAINS THE PROPERTY OF RHEINZINK. | | SHEET: | FLRP-2 |

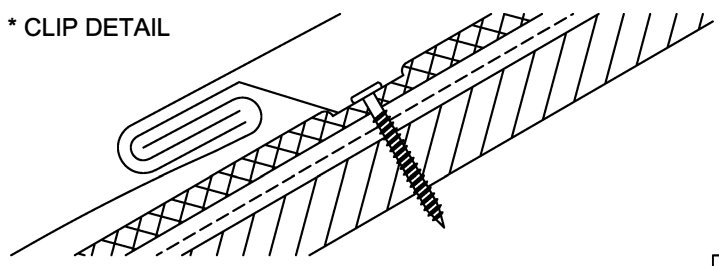
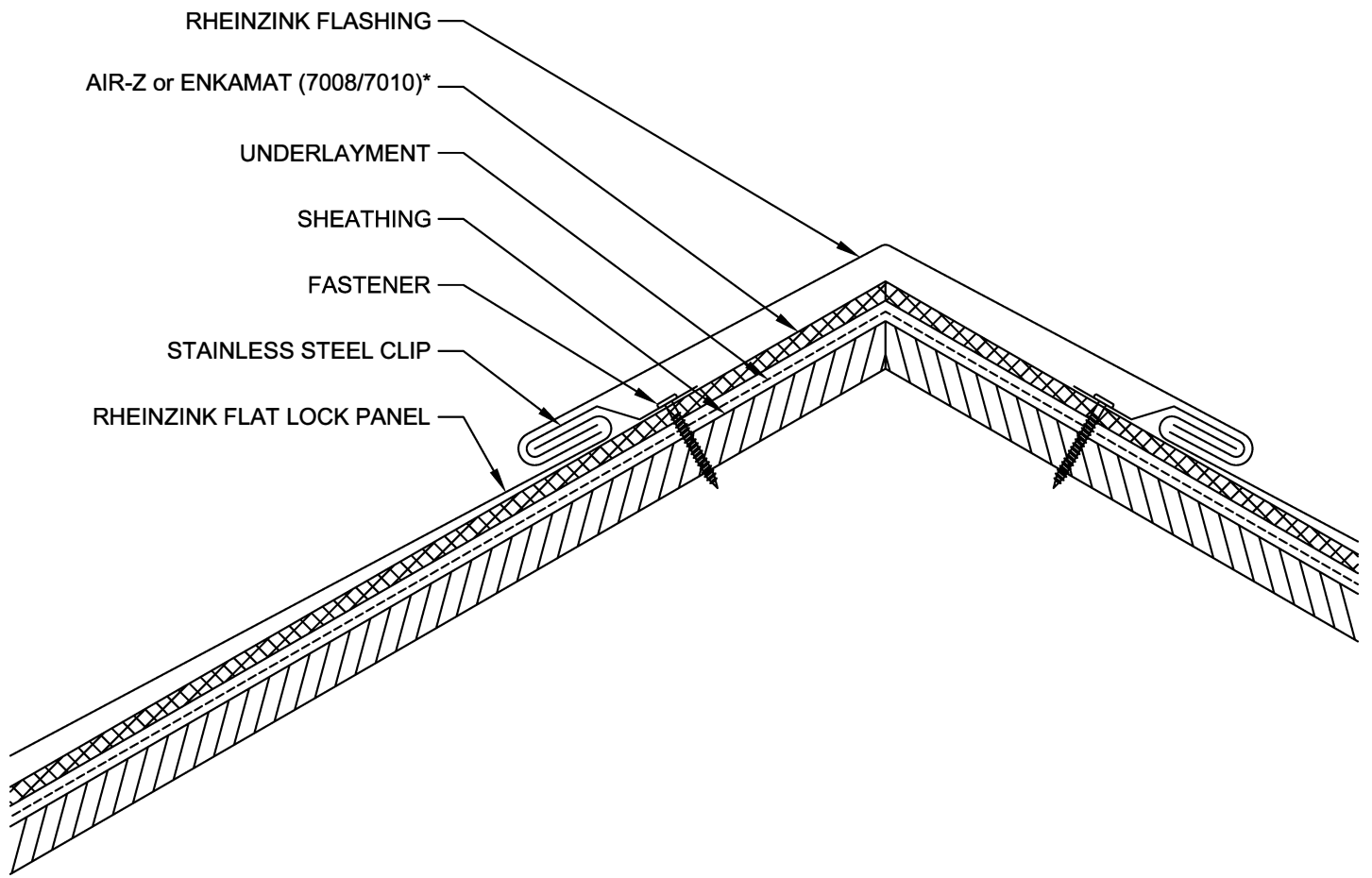

NOTES:

1. RHEINZINK RECOMMENDS STAINLESS STEEL FASTENERS AND CLIPS.
2. FLAT LOCK PANELS REQUIRE A MINIMUM OF 3:12 PITCH. FLAT LOCK PANEL ROOF SYSTEMS UP TO 6 IN 12 REQUIRE AIR-Z OR EN KAMAT (7008/7010) FLAT LOCK PANELS OVER A 6 IN 12 PITCH REQUIRE AIR-Z OR ENKAMAT (7008/7010).

| | | |
|--|--------------------------------------|-----------------------|
| RHEINZINK® Website: www.rheinzink.us E-mail: info@rheinzink.com | | |
| INFORMATION AND DETAILS HEREIN ARE ONLY A BASELINE FOR SYSTEM DESIGN AND INSTALLATION. MODIFICATION TO MEET PROJECT REQUIREMENTS IS THE RESPONSIBILITY OF THE DESIGNER AND ARCHITECT. RHEINZINK AMERICA STAFF ARE AVAILABLE TO ASSIST THE DESIGNER AND ARCHITECT IN THIS PROCESS. RHEINZINK AMERICA MAKES NO REPRESENTATIONS AND WARRANTIES OTHER THAN THOSE EXPRESSED HEREIN. | | |
| PROJECT: | FLAT LOCK ROOF PANEL DETAILS | DATE: 5-2020 |
| DRAWING TITLE: | RIDGE / HIP DETAIL - OPTION 1 | SCALE: N.T.S. |
| COPYRIGHT RESERVED. THIS DRAWING REMAINS THE PROPERTY OF RHEINZINK. | | SHEET: FLRP-3A |

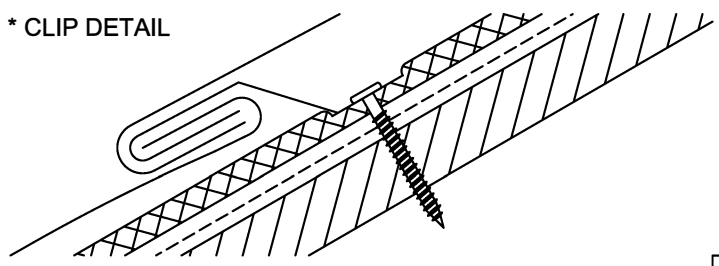
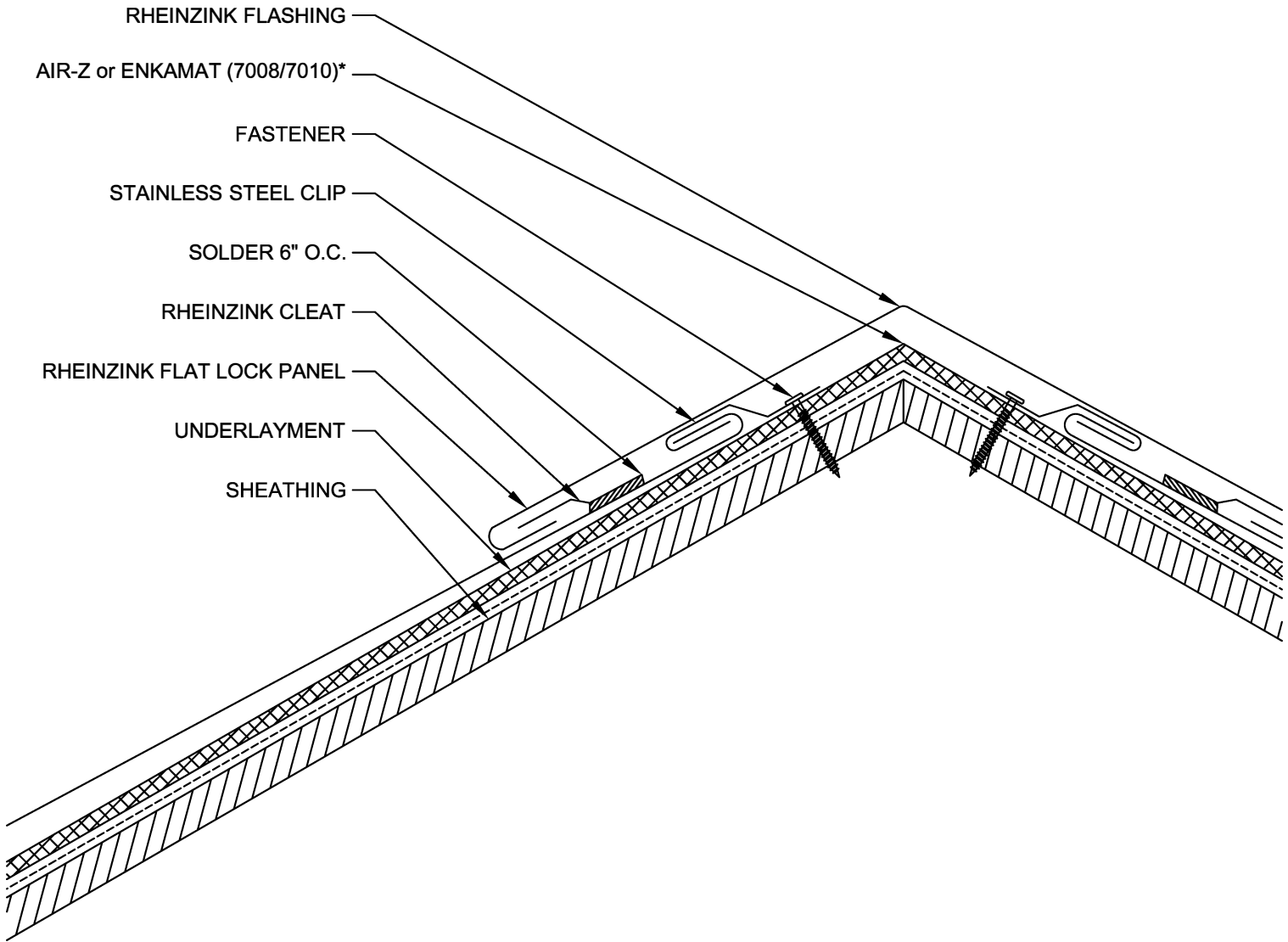

NOTES:

1. RHEINZINK RECOMMENDS STAINLESS STEEL FASTENERS AND CLIPS.
2. FLAT LOCK PANELS REQUIRE A MINIMUM OF 3:12 PITCH. FLAT LOCK PANEL ROOF SYSTEMS UP TO 6 IN 12 REQUIRE AIR-Z OR EN KAMAT (7008/7010) FLAT LOCK PANELS OVER A 6 IN 12 PITCH REQUIRE AIR-Z OR ENKAMAT (7008/7010).

| | |
|--|-----------------------|
|  Website: www.rheinzink.us E-mail: info@rheinzink.com | |
| INFORMATION AND DETAILS HEREIN ARE ONLY A BASELINE FOR SYSTEM DESIGN AND INSTALLATION. MODIFICATION TO MEET PROJECT REQUIREMENTS IS THE RESPONSIBILITY OF THE DESIGNER AND ARCHITECT. RHEINZINK AMERICA STAFF ARE AVAILABLE TO ASSIST THE DESIGNER AND ARCHITECT IN THIS PROCESS. RHEINZINK AMERICA MAKES NO REPRESENTATIONS AND WARRANTIES OTHER THAN THOSE EXPRESSED HEREIN. | |
| PROJECT: FLAT LOCK ROOF PANEL DETAILS | DATE: 5-2020 |
| DRAWING TITLE: RIDGE / HIP DETAIL - OPTION 2 | SCALE: N.T.S. |
| COPYRIGHT RESERVED. THIS DRAWING REMAINS THE PROPERTY OF RHEINZINK. | SHEET: FLRP-3B |

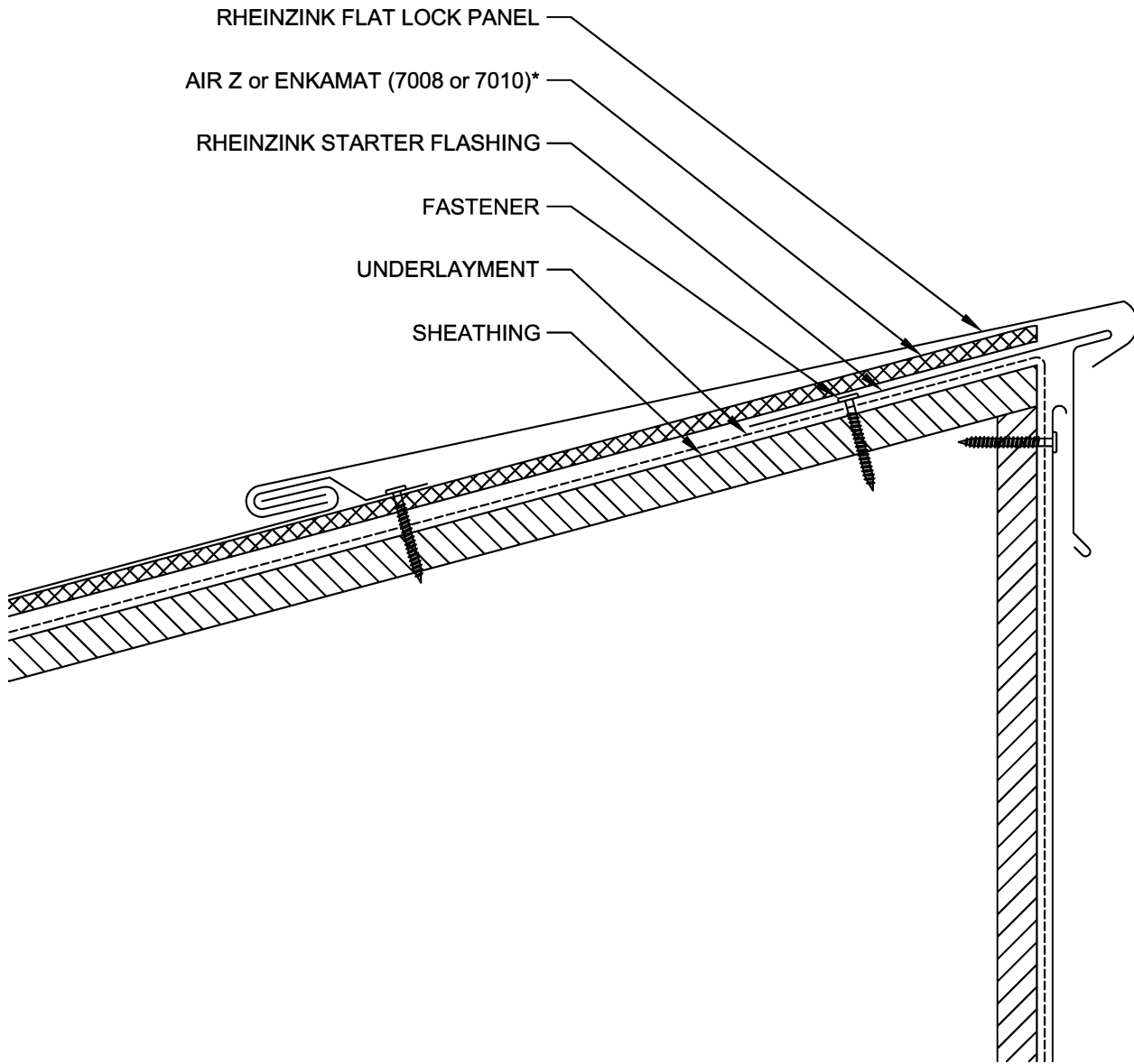

* CLIP DETAIL

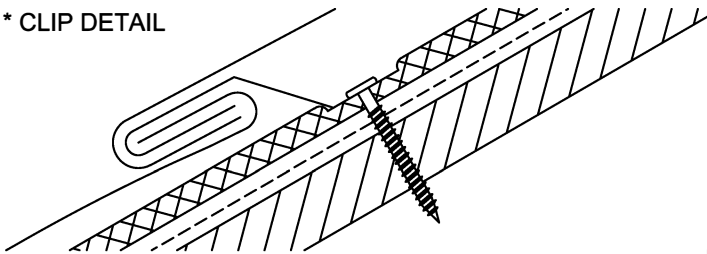

NOTES:

1. RHEINZINK RECOMMENDS STAINLESS STEEL FASTENERS AND CLIPS.
2. FLAT LOCK PANELS REQUIRE A MINIMUM OF 3:12 PITCH. FLAT LOCK PANEL ROOF SYSTEMS UP TO 6 IN 12 REQUIRE AIR-Z OR EN KAMAT (7008/7010) FLAT LOCK PANELS OVER A 6 IN 12 PITCH REQUIRE AIR-Z OR ENKAMAT (7008/7010).



Website: www.rheinzink.us E-mail: info@rheinzink.com

INFORMATION AND DETAILS HEREIN ARE ONLY A BASELINE FOR SYSTEM DESIGN AND INSTALLATION. MODIFICATION TO MEET PROJECT REQUIREMENTS IS THE RESPONSIBILITY OF THE DESIGNER AND ARCHITECT. RHEINZINK AMERICA STAFF ARE AVAILABLE TO ASSIST THE DESIGNER AND ARCHITECT IN THIS PROCESS. RHEINZINK AMERICA MAKES NO REPRESENTATIONS AND WARRANTIES OTHER THAN THOSE EXPRESSED HEREIN.

| | | | |
|---|------------------------------|--------|--------|
| PROJECT: | FLAT LOCK ROOF PANEL DETAILS | DATE: | 5-2020 |
| DRAWING TITLE: | MONO-PITCH RIDGE DETAIL | SCALE: | N.T.S. |
| COPYRIGHT RESERVED. THIS DRAWING REMAINS THE PROPERTY OF RHEINZINK. | | SHEET: | FLRP-4 |

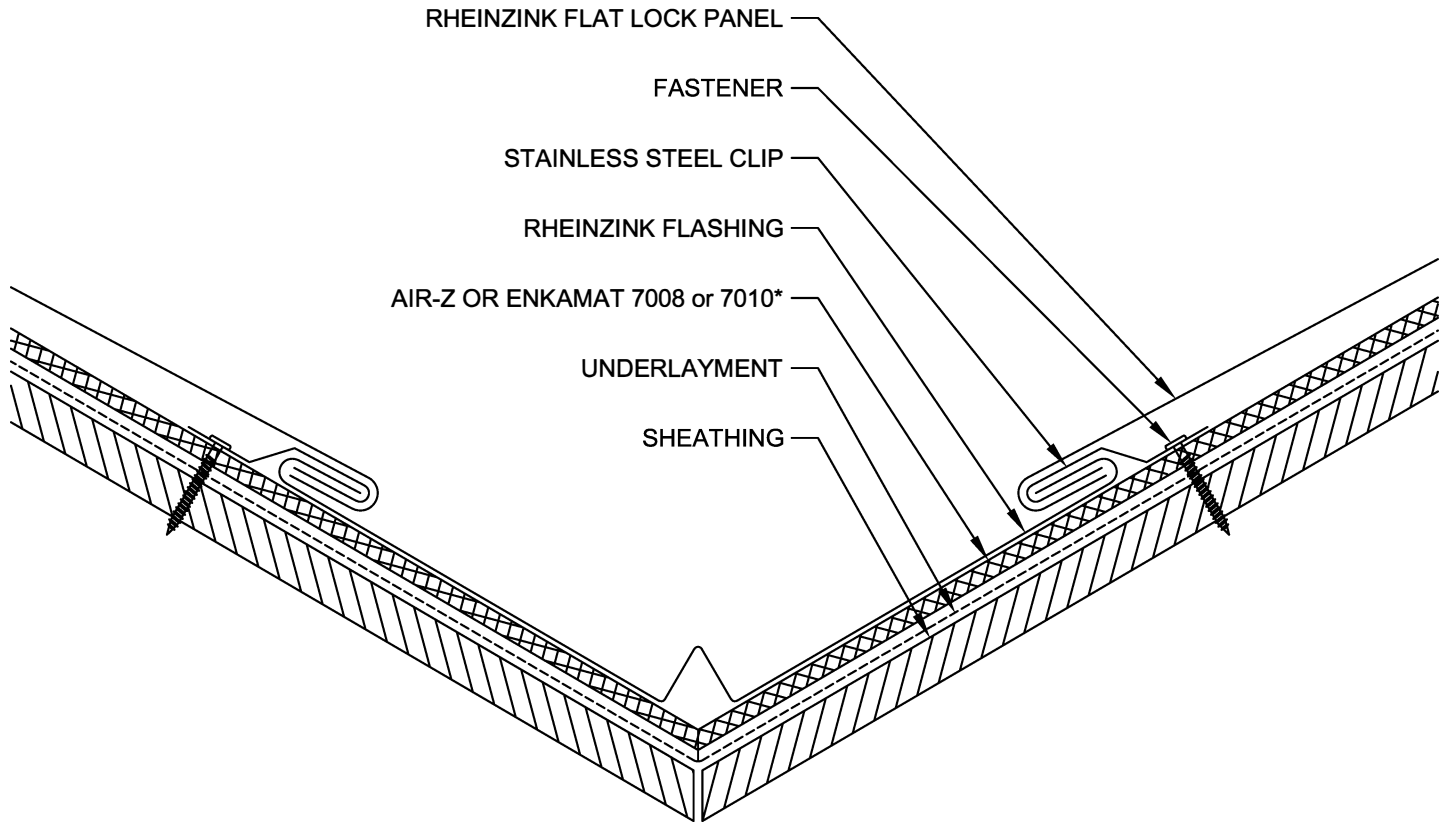

* CLIP DETAIL

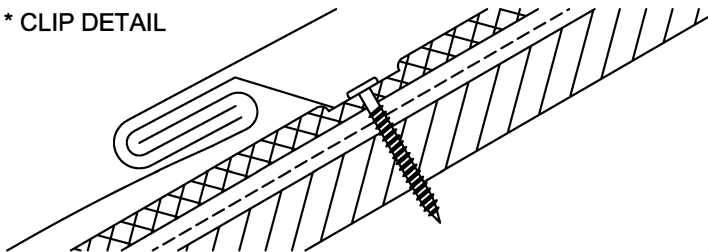

NOTES:

1. RHEINZINK RECOMMENDS STAINLESS STEEL FASTENERS AND CLIPS.
2. FLAT LOCK PANELS REQUIRE A MINIMUM OF 3:12 PITCH. FLAT LOCK PANEL ROOF SYSTEMS UP TO 6 IN 12 REQUIRE AIR-Z OR ENKAMAT (7008/7010) FLAT LOCK PANELS OVER A 6 IN 12 PITCH REQUIRE AIR-Z OR ENKAMAT (7008/7010).



Website: www.rheinzink.us E-mail: info@rheinzink.com

INFORMATION AND DETAILS HEREIN ARE ONLY A BASELINE FOR SYSTEM DESIGN AND INSTALLATION. MODIFICATION TO MEET PROJECT REQUIREMENTS IS THE RESPONSIBILITY OF THE DESIGNER AND ARCHITECT. RHEINZINK AMERICA STAFF ARE AVAILABLE TO ASSIST THE DESIGNER AND ARCHITECT IN THIS PROCESS. RHEINZINK AMERICA MAKES NO REPRESENTATIONS AND WARRANTIES OTHER THAN THOSE EXPRESSED HEREIN.

| | | | |
|---|-------------------------------------|--------|----------------|
| PROJECT: | FLAT LOCK ROOF PANEL DETAILS | DATE: | 5-2020 |
| DRAWING TITLE: | VALLEY DETAIL - OP 1 | SCALE: | N.T.S. |
| COPYRIGHT RESERVED. THIS DRAWING REMAINS THE PROPERTY OF RHEINZINK. | | SHEET: | FLRP-5A |

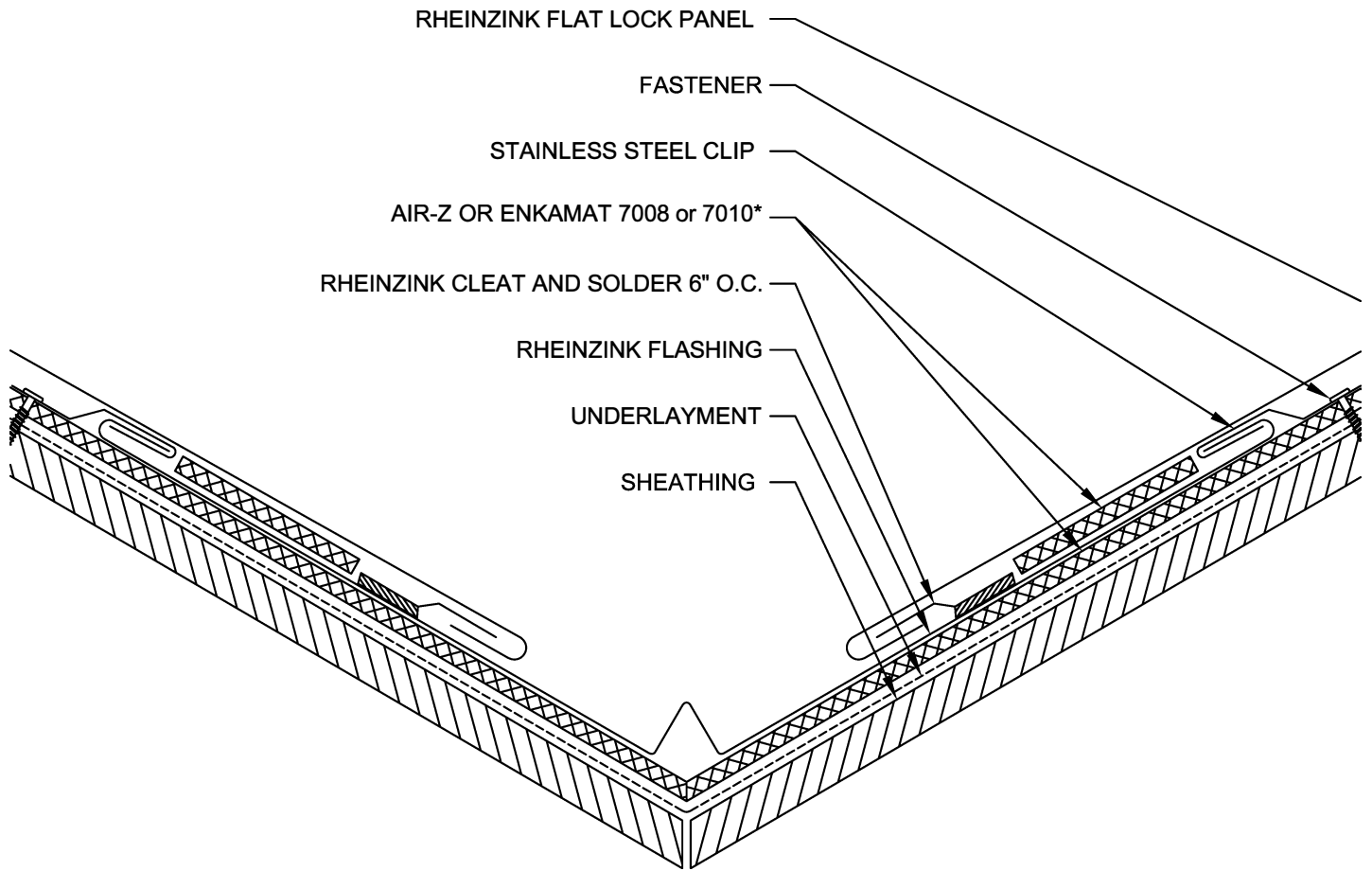

* CLIP DETAIL

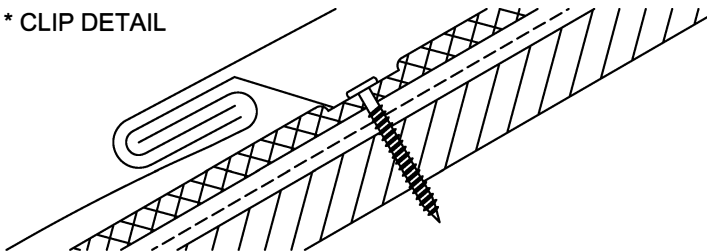

NOTES:

1. RHEINZINK RECOMMENDS STAINLESS STEEL FASTENERS AND CLIPS.
2. FLAT LOCK PANELS REQUIRE A MINIMUM OF 3:12 PITCH. FLAT LOCK PANEL ROOF SYSTEMS UP TO 6 IN 12 REQUIRE BOTH PROROOING AND AIR-Z OR ENKAMAT (7008/7010) FLAT LOCK PANELS OVER A 6 IN 12 PITCH REQUIRE AIR-Z OR ENKAMAT (7008/7010) OR PROROOING.



Website: www.rheinzink.us E-mail: info@rheinzink.com

INFORMATION AND DETAILS HEREIN ARE ONLY A BASELINE FOR SYSTEM DESIGN AND INSTALLATION. MODIFICATION TO MEET PROJECT REQUIREMENTS IS THE RESPONSIBILITY OF THE DESIGNER AND ARCHITECT. RHEINZINK AMERICA STAFF ARE AVAILABLE TO ASSIST THE DESIGNER AND ARCHITECT IN THIS PROCESS. RHEINZINK AMERICA MAKES NO REPRESENTATIONS AND WARRANTIES OTHER THAN THOSE EXPRESSED HEREIN.

| | | | |
|---|-------------------------------------|--------|----------------|
| PROJECT: | FLAT LOCK ROOF PANEL DETAILS | DATE: | 5-2020 |
| DRAWING TITLE: | VALLEY DETAIL - OP 2 | SCALE: | N.T.S. |
| COPYRIGHT RESERVED. THIS DRAWING REMAINS THE PROPERTY OF RHEINZINK. | | SHEET: | FLRP-5B |

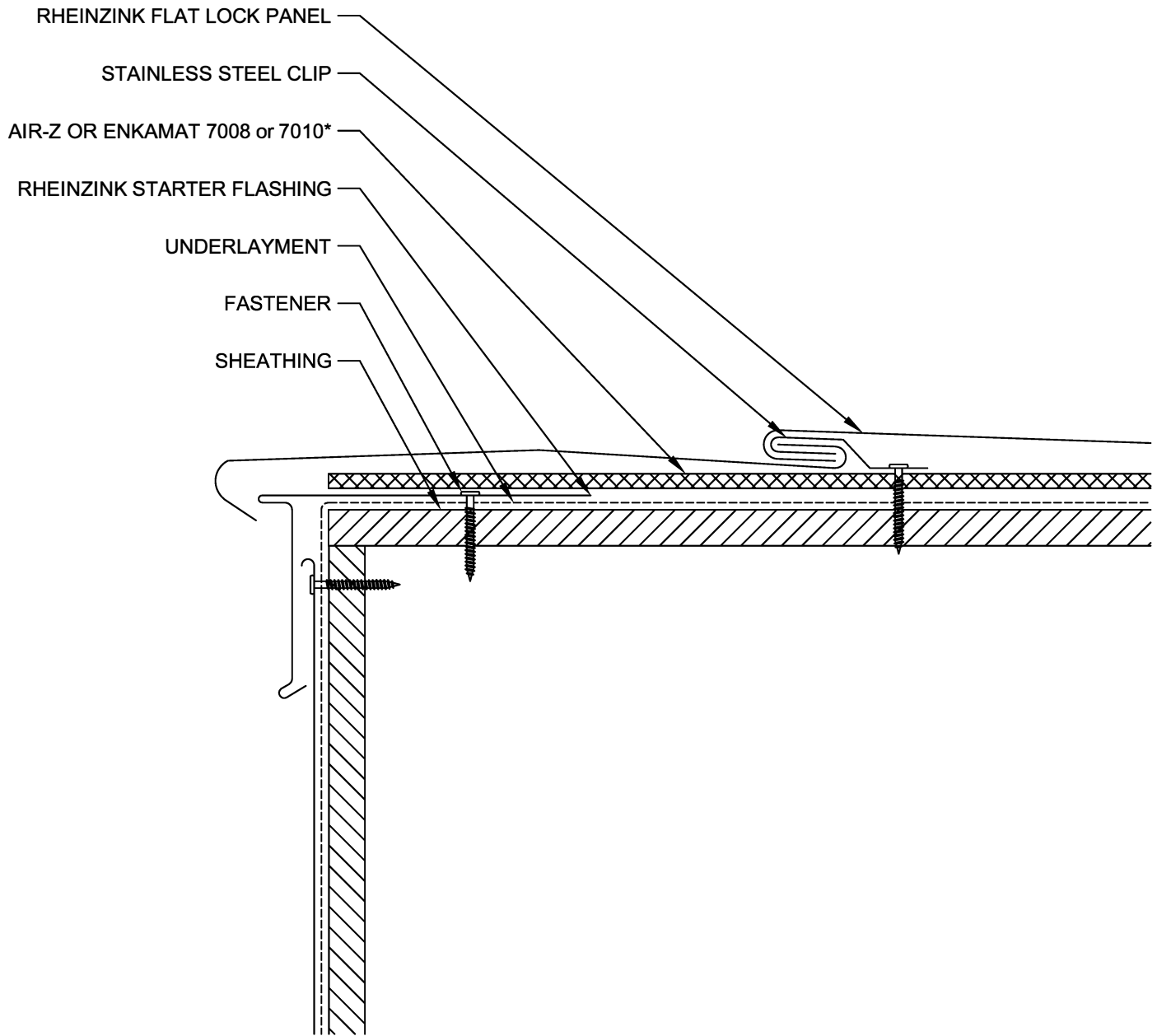

* CLIP DETAIL

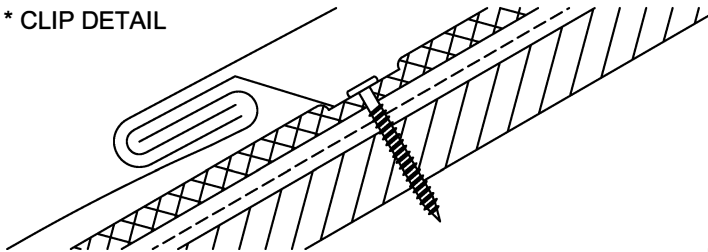

NOTES:

1. RHEINZINK RECOMMENDS STAINLESS STEEL FASTENERS AND CLIPS.
2. FLAT LOCK PANELS REQUIRE A MINIMUM OF 3:12 PITCH. FLAT LOCK PANEL ROOF SYSTEMS UP TO 6 IN 12 REQUIRE BOTH PROROOING AND AIR-Z OR ENKAMAT (7008/7010) FLAT LOCK PANELS OVER A 6 IN 12 PITCH REQUIRE AIR-Z OR ENKAMAT (7008/7010) OR PROROOING.



Website: www.rheinzink.us E-mail: info@rheinzink.com

INFORMATION AND DETAILS HEREIN ARE ONLY A BASELINE FOR SYSTEM DESIGN AND INSTALLATION. MODIFICATION TO MEET PROJECT REQUIREMENTS IS THE RESPONSIBILITY OF THE DESIGNER AND ARCHITECT. RHEINZINK AMERICA STAFF ARE AVAILABLE TO ASSIST THE DESIGNER AND ARCHITECT IN THIS PROCESS. RHEINZINK AMERICA MAKES NO REPRESENTATIONS AND WARRANTIES OTHER THAN THOSE EXPRESSED HEREIN.

| | | | |
|---|------------------------------|--------|--------|
| PROJECT: | FLAT LOCK ROOF PANEL DETAILS | DATE: | 5-2020 |
| DRAWING TITLE: | RAKE EDGE DETAIL - OP 1 | SCALE: | N.T.S. |
| COPYRIGHT RESERVED. THIS DRAWING REMAINS THE PROPERTY OF RHEINZINK. | | SHEET: | FLRP-6 |

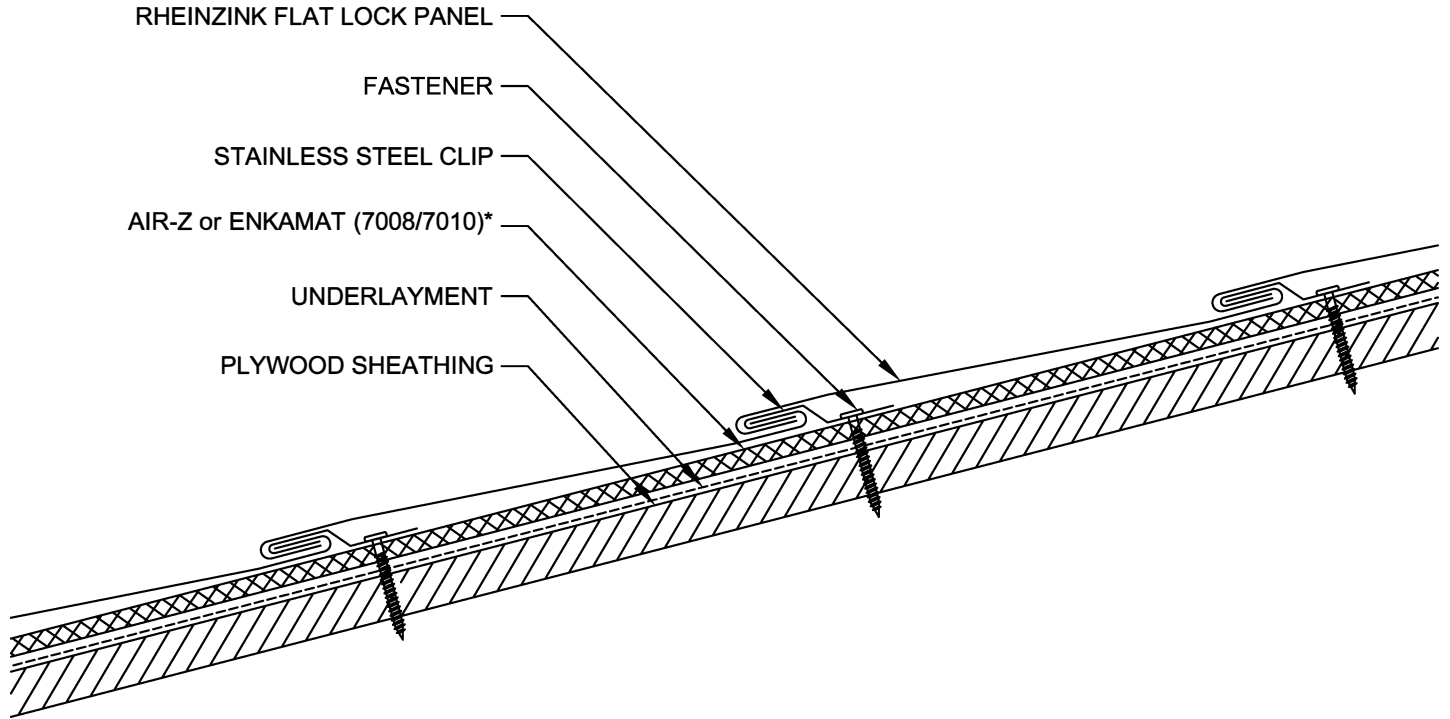

* CLIP DETAIL

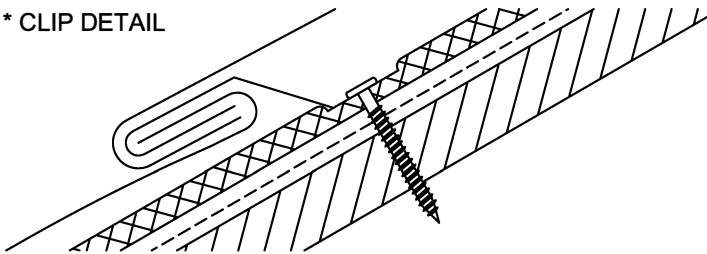

NOTES:

1. RHEINZINK RECOMMENDS STAINLESS STEEL FASTENERS AND CLIPS.
2. FLAT LOCK PANELS REQUIRE A MINIMUM OF 3:12 PITCH. FLAT LOCK PANEL ROOF SYSTEMS UP TO 6 IN 12 REQUIRE BOTH PROROOING AND AIR-Z OR ENKAMAT (7008/7010) FLAT LOCK PANELS OVER A 6 IN 12 PITCH REQUIRE AIR-Z OR ENKAMAT (7008/7010) OR PROROOING.



Website: www.rheinzink.us E-mail: info@rheinzink.com

INFORMATION AND DETAILS HEREIN ARE ONLY A BASELINE FOR SYSTEM DESIGN AND INSTALLATION. MODIFICATION TO MEET PROJECT REQUIREMENTS IS THE RESPONSIBILITY OF THE DESIGNER AND ARCHITECT. RHEINZINK AMERICA STAFF ARE AVAILABLE TO ASSIST THE DESIGNER AND ARCHITECT IN THIS PROCESS. RHEINZINK AMERICA MAKES NO REPRESENTATIONS AND WARRANTIES OTHER THAN THOSE EXPRESSED HEREIN.

| | | | |
|---|------------------------------|--------|--------|
| PROJECT: | FLAT LOCK ROOF PANEL DETAILS | DATE: | 5-2020 |
| DRAWING TITLE: | CROSS JOINT DETAIL | SCALE: | N.T.S. |
| COPYRIGHT RESERVED. THIS DRAWING REMAINS THE PROPERTY OF RHEINZINK. | | SHEET: | FLRP-7 |

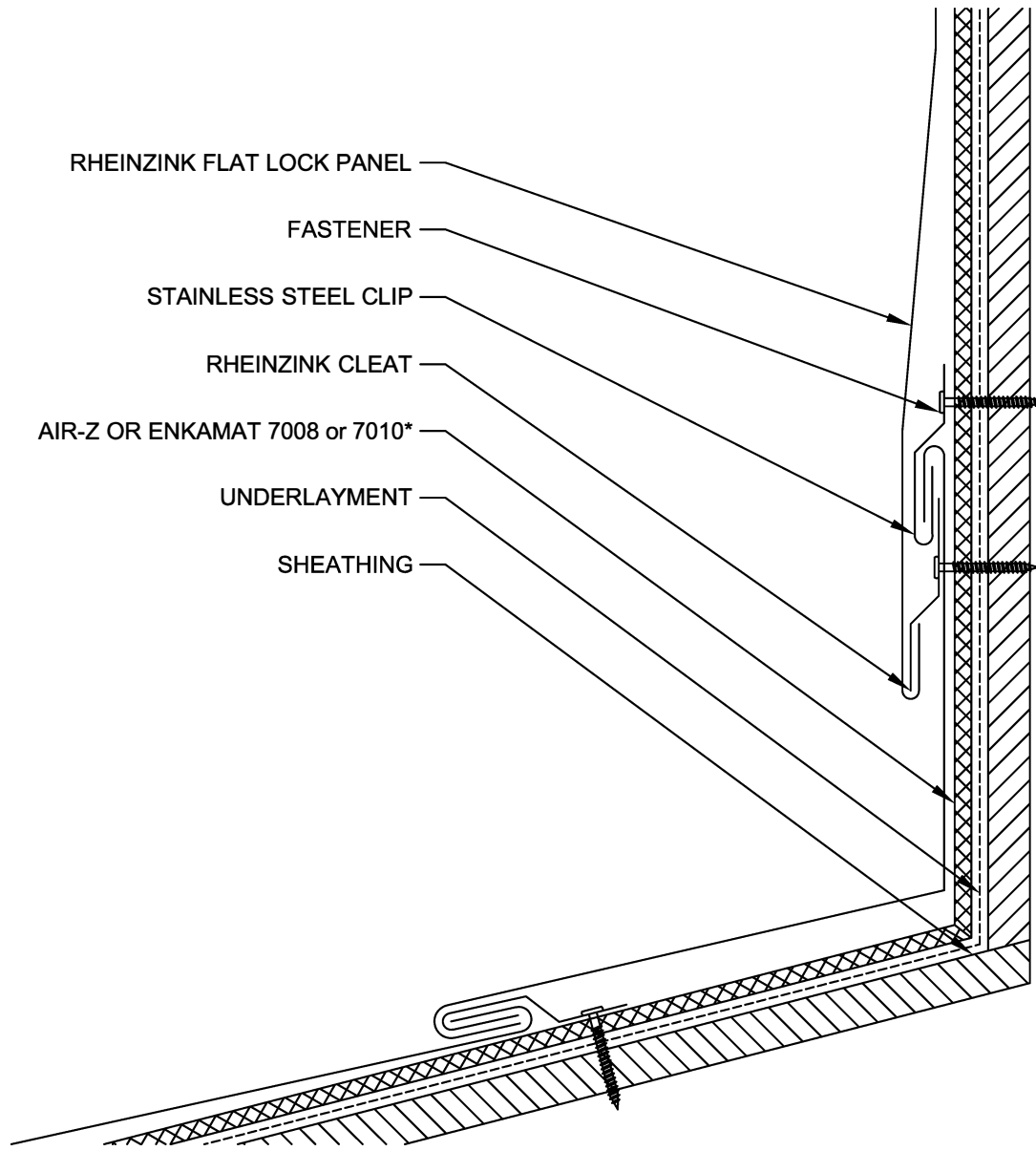

RHEINZINK FLAT LOCK PANEL
 FASTENER
 STAINLESS STEEL CLIP
 RHEINZINK CLEAT
 AIR-Z OR ENKAMAT 7008 or 7010*
 UNDERLAYMENT
 SHEATHING

* CLIP DETAIL

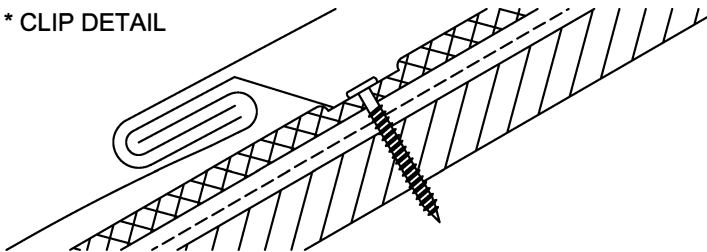

NOTES:

1. RHEINZINK RECOMMENDS STAINLESS STEEL FASTENERS AND CLIPS.
2. FLAT LOCK PANELS REQUIRE A MINIMUM OF 3:12 PITCH. FLAT LOCK PANEL ROOF SYSTEMS UP TO 6 IN 12 REQUIRE BOTH PROROOING AND AIR-Z OR ENKAMAT (7008/7010) FLAT LOCK PANELS OVER A 6 IN 12 PITCH REQUIRE AIR-Z OR ENKAMAT (7008/7010) OR PROROOING.



Website: www.rheinzink.us E-mail: info@rheinzink.com

INFORMATION AND DETAILS HEREIN ARE ONLY A BASELINE FOR SYSTEM DESIGN AND INSTALLATION. MODIFICATION TO MEET PROJECT REQUIREMENTS IS THE RESPONSIBILITY OF THE DESIGNER AND ARCHITECT. RHEINZINK AMERICA STAFF ARE AVAILABLE TO ASSIST THE DESIGNER AND ARCHITECT IN THIS PROCESS. RHEINZINK AMERICA MAKES NO REPRESENTATIONS AND WARRANTIES OTHER THAN THOSE EXPRESSED HEREIN.

| | | | |
|---|--------------------------------|--------|--------|
| PROJECT: | FLAT LOCK ROOF PANEL DETAILS | DATE: | 5-2020 |
| DRAWING TITLE: | ROOF TO WALL TRANSITION DETAIL | SCALE: | N.T.S. |
| COPYRIGHT RESERVED. THIS DRAWING REMAINS THE PROPERTY OF RHEINZINK. | | SHEET: | FLRP-8 |

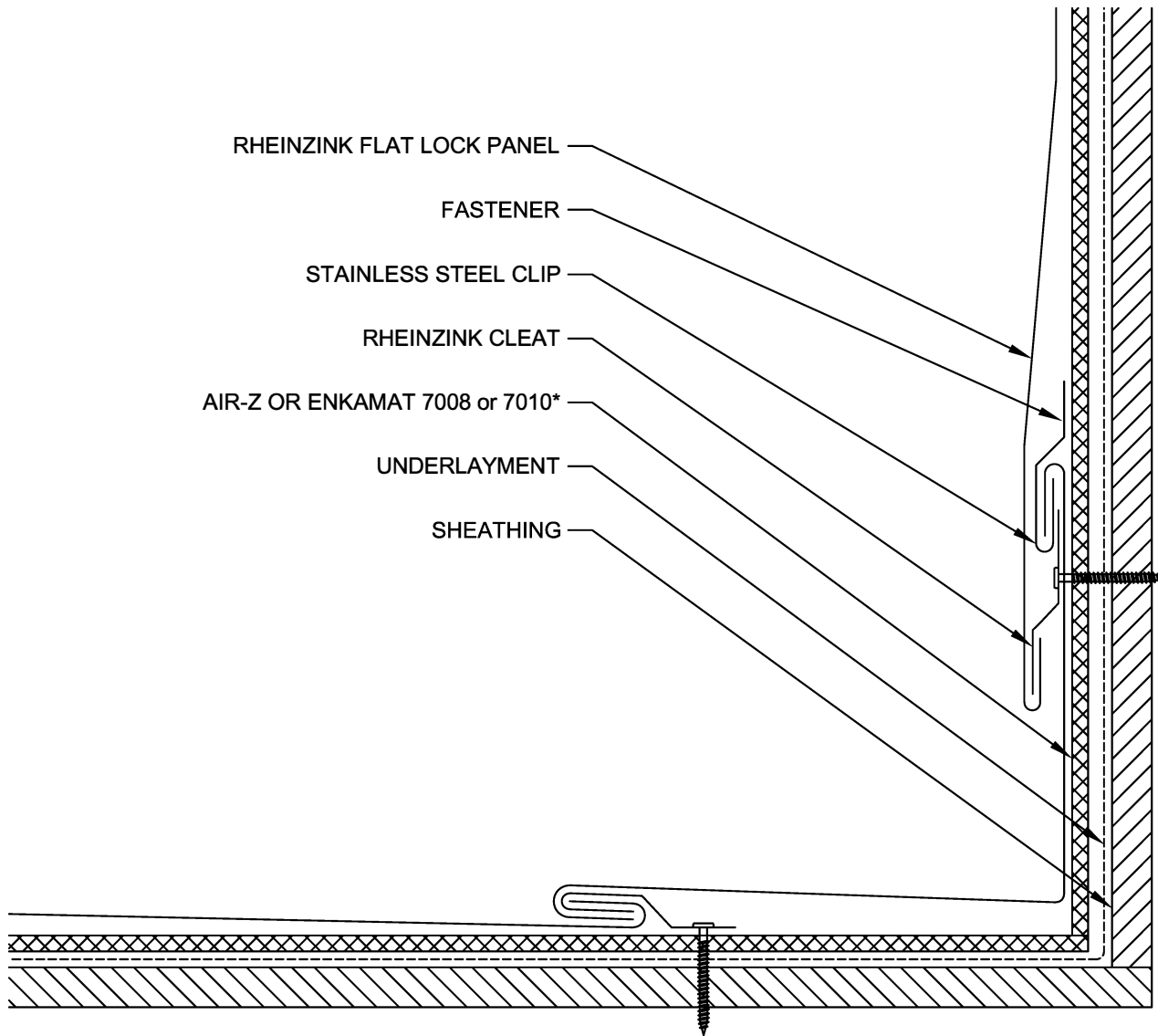

* CLIP DETAIL

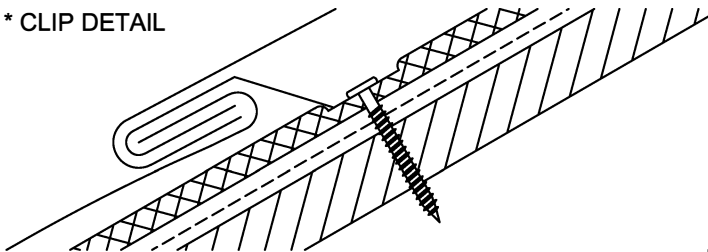

NOTES:

1. RHEINZINK RECOMMENDS STAINLESS STEEL FASTENERS AND CLIPS.
2. FLAT LOCK PANELS REQUIRE A MINIMUM OF 3:12 PITCH. FLAT LOCK PANEL ROOF SYSTEMS UP TO 6 IN 12 REQUIRE BOTH PROROOING AND AIR-Z OR ENKAMAT (7008/7010) FLAT LOCK PANELS OVER A 6 IN 12 PITCH REQUIRE AIR-Z OR ENKAMAT (7008/7010) OR PROROOING.



Website: www.rheinzink.us E-mail: info@rheinzink.com

INFORMATION AND DETAILS HEREIN ARE ONLY A BASELINE FOR SYSTEM DESIGN AND INSTALLATION. MODIFICATION TO MEET PROJECT REQUIREMENTS IS THE RESPONSIBILITY OF THE DESIGNER AND ARCHITECT. RHEINZINK AMERICA STAFF ARE AVAILABLE TO ASSIST THE DESIGNER AND ARCHITECT IN THIS PROCESS. RHEINZINK AMERICA MAKES NO REPRESENTATIONS AND WARRANTIES OTHER THAN THOSE EXPRESSED HEREIN.

| | | | |
|---|------------------------------|--------|--------|
| PROJECT: | FLAT LOCK ROOF PANEL DETAILS | DATE: | 5-2020 |
| DRAWING TITLE: | SIDEWALL DETAIL | SCALE: | N.T.S. |
| COPYRIGHT RESERVED. THIS DRAWING REMAINS THE PROPERTY OF RHEINZINK. | | SHEET: | FLRP-9 |

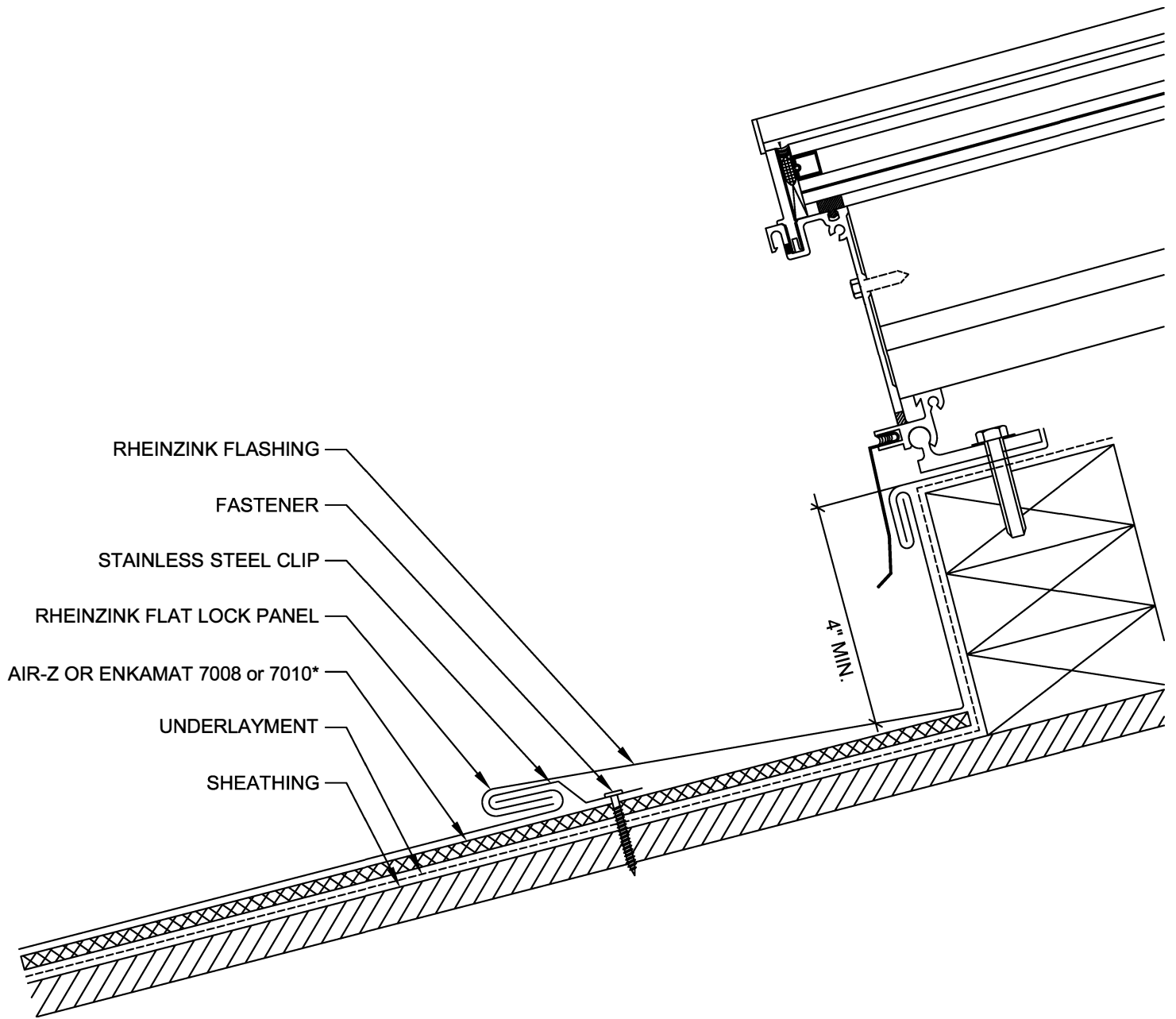

* CLIP DETAIL

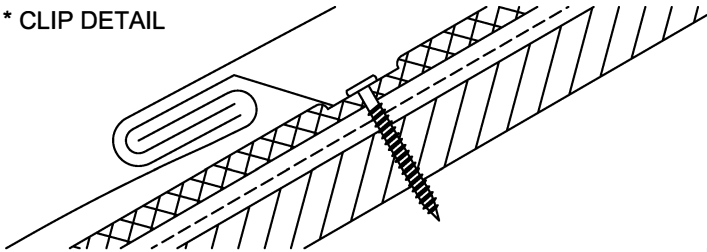

NOTES:

1. RHEINZINK RECOMMENDS STAINLESS STEEL FASTENERS AND CLIPS.
2. FLAT LOCK PANELS REQUIRE A MINIMUM OF 3:12 PITCH. FLAT LOCK PANEL ROOF SYSTEMS UP TO 6 IN 12 REQUIRE BOTH PROROOING AND AIR-Z OR ENKAMAT (7008/7010) FLAT LOCK PANELS OVER A 6 IN 12 PITCH REQUIRE AIR-Z OR ENKAMAT (7008/7010) OR PROROOING.



Website: www.rheinzink.us E-mail: info@rheinzink.com

INFORMATION AND DETAILS HEREIN ARE ONLY A BASELINE FOR SYSTEM DESIGN AND INSTALLATION. MODIFICATION TO MEET PROJECT REQUIREMENTS IS THE RESPONSIBILITY OF THE DESIGNER AND ARCHITECT. RHEINZINK AMERICA STAFF ARE AVAILABLE TO ASSIST THE DESIGNER AND ARCHITECT IN THIS PROCESS. RHEINZINK AMERICA MAKES NO REPRESENTATIONS AND WARRANTIES OTHER THAN THOSE EXPRESSED HEREIN.

| | | | |
|---|------------------------------|--------|---------|
| PROJECT: | FLAT LOCK ROOF PANEL DETAILS | DATE: | 5-2020 |
| DRAWING TITLE: | SKYLIGHT SILL DETAIL | SCALE: | N.T.S. |
| COPYRIGHT RESERVED. THIS DRAWING REMAINS THE PROPERTY OF RHEINZINK. | | SHEET: | FLRP-10 |

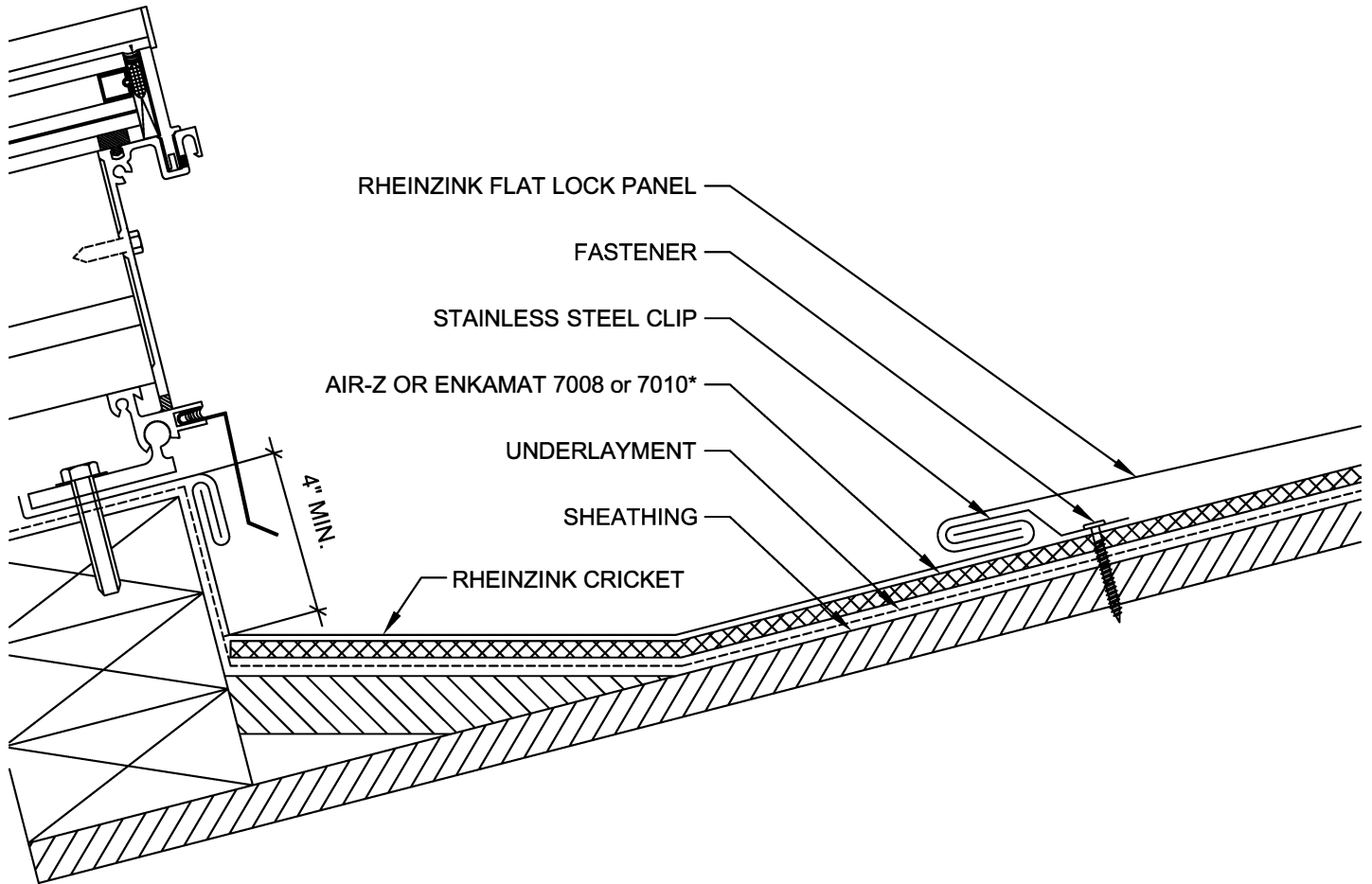

* CLIP DETAIL

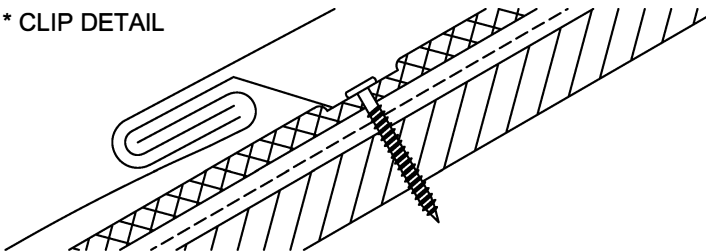

NOTES:

1. RHEINZINK RECOMMENDS STAINLESS STEEL FASTENERS AND CLIPS.
2. FLAT LOCK PANELS REQUIRE A MINIMUM OF 3:12 PITCH. FLAT LOCK PANEL ROOF SYSTEMS UP TO 6 IN 12 REQUIRE BOTH PROROOING AND AIR-Z OR ENKAMAT (7008/7010) FLAT LOCK PANELS OVER A 6 IN 12 PITCH REQUIRE AIR-Z OR ENKAMAT (7008/7010) OR PROROOING.



Website: www.rheinzink.us E-mail: info@rheinzink.com

INFORMATION AND DETAILS HEREIN ARE ONLY A BASELINE FOR SYSTEM DESIGN AND INSTALLATION. MODIFICATION TO MEET PROJECT REQUIREMENTS IS THE RESPONSIBILITY OF THE DESIGNER AND ARCHITECT. RHEINZINK AMERICA STAFF ARE AVAILABLE TO ASSIST THE DESIGNER AND ARCHITECT IN THIS PROCESS. RHEINZINK AMERICA MAKES NO REPRESENTATIONS AND WARRANTIES OTHER THAN THOSE EXPRESSED HEREIN.

| | | | |
|---|------------------------------|--------|---------|
| PROJECT: | FLAT LOCK ROOF PANEL DETAILS | DATE: | 5-2020 |
| DRAWING TITLE: | SKYLIGHT HEAD DETAIL | SCALE: | N.T.S. |
| COPYRIGHT RESERVED. THIS DRAWING REMAINS THE PROPERTY OF RHEINZINK. | | SHEET: | FLRP-11 |

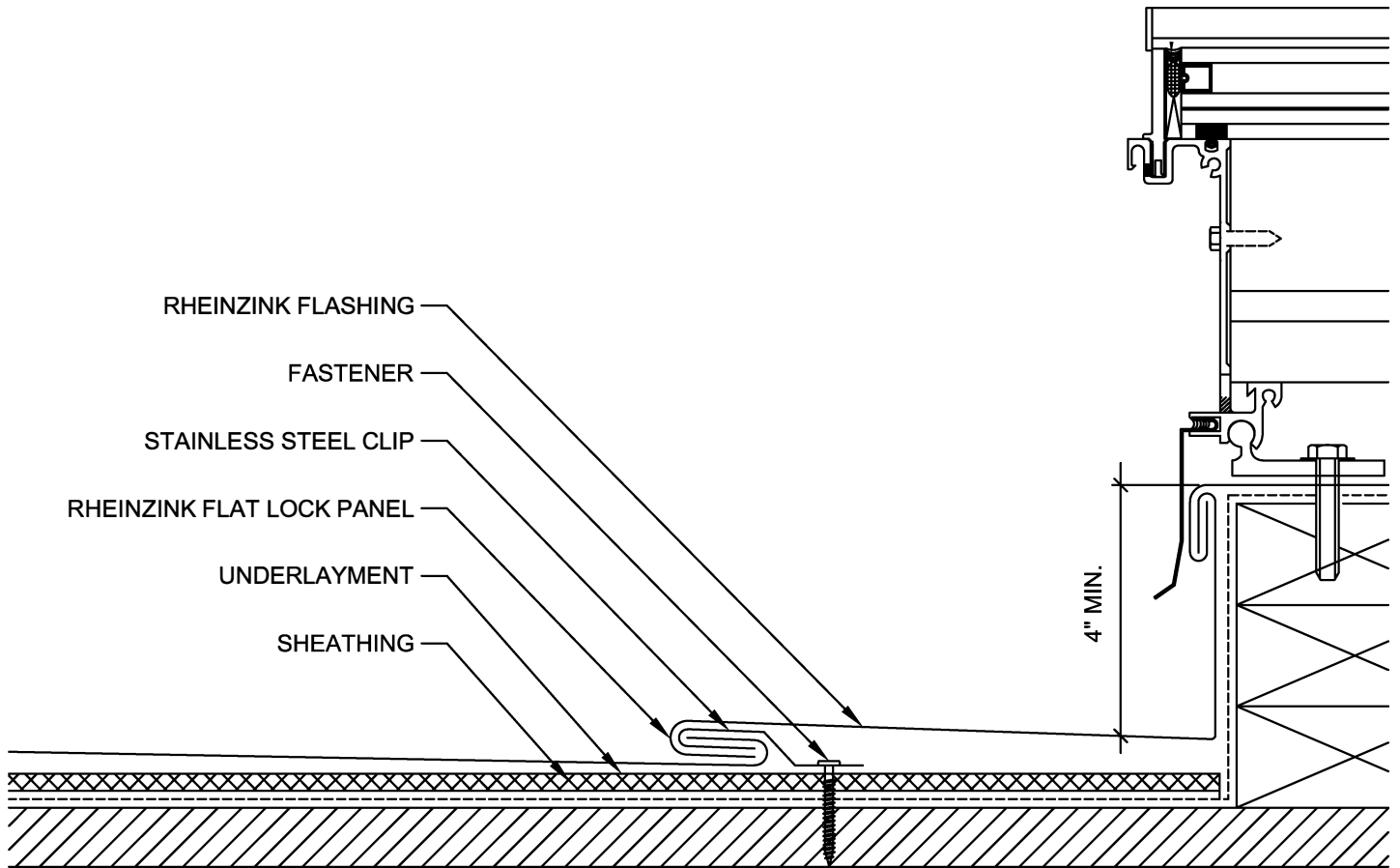

* CLIP DETAIL

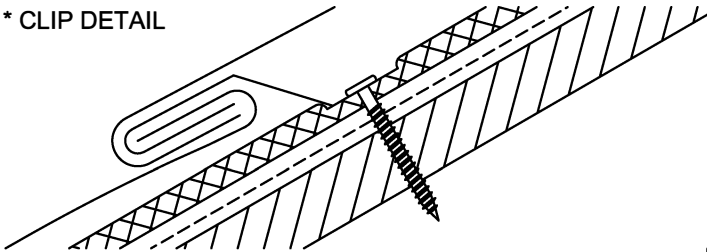

NOTES:

1. RHEINZINK RECOMMENDS STAINLESS STEEL FASTENERS AND CLIPS.
2. FLAT LOCK PANELS REQUIRE A MINIMUM OF 3:12 PITCH. FLAT LOCK PANEL ROOF SYSTEMS UP TO 6 IN 12 REQUIRE BOTH PROROOING AND AIR-Z OR ENKAMAT (7008/7010) FLAT LOCK PANELS OVER A 6 IN 12 PITCH REQUIRE AIR-Z OR ENKAMAT (7008/7010) OR PROROOING.

| | | |
|--|-------------------------------------|-----------------------|
|  Website: www.rheinzink.us E-mail: info@rheinzink.com | | |
| INFORMATION AND DETAILS HEREIN ARE ONLY A BASELINE FOR SYSTEM DESIGN AND INSTALLATION. MODIFICATION TO MEET PROJECT REQUIREMENTS IS THE RESPONSIBILITY OF THE DESIGNER AND ARCHITECT. RHEINZINK AMERICA STAFF ARE AVAILABLE TO ASSIST THE DESIGNER AND ARCHITECT IN THIS PROCESS. RHEINZINK AMERICA MAKES NO REPRESENTATIONS AND WARRANTIES OTHER THAN THOSE EXPRESSED HEREIN. | | |
| PROJECT: | FLAT LOCK ROOF PANEL DETAILS | DATE: 5-2020 |
| DRAWING TITLE: | SKYLIGHT JAMB DETAIL | SCALE: N.T.S. |
| COPYRIGHT RESERVED. THIS DRAWING REMAINS THE PROPERTY OF RHEINZINK. | | SHEET: FLRP-12 |

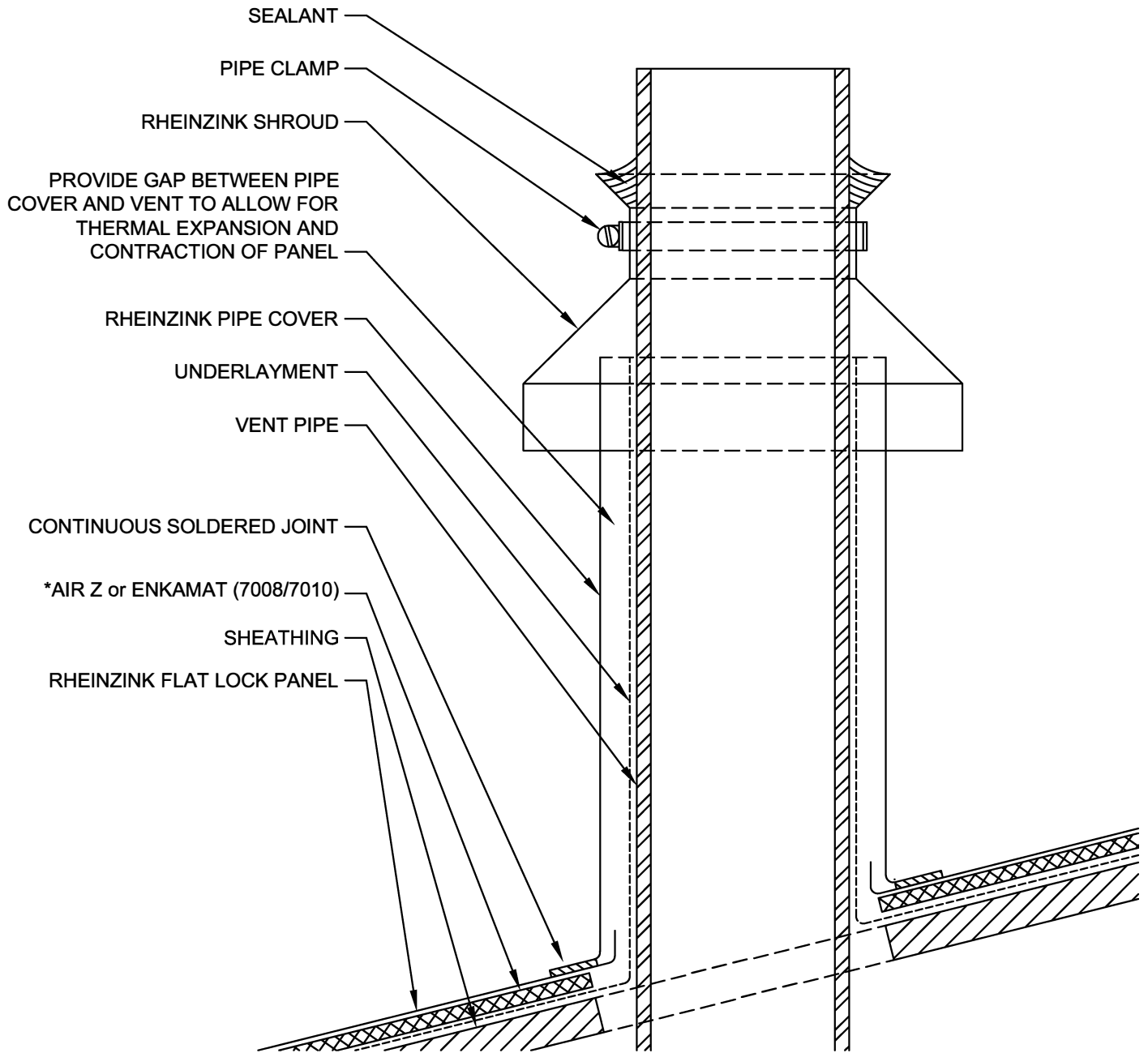

* CLIP DETAIL

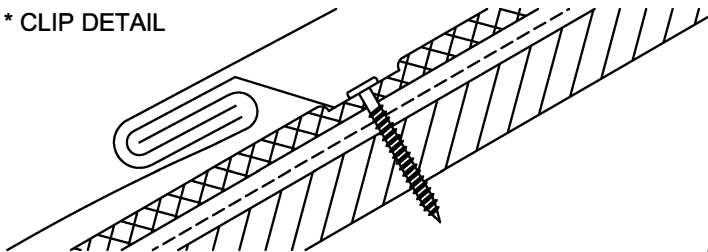

NOTES:

1. RHEINZINK RECOMMENDS STAINLESS STEEL FASTENERS AND CLIPS.
2. FLAT LOCK PANELS REQUIRE A MINIMUM OF 3:12 PITCH. FLAT LOCK PANEL ROOF SYSTEMS UP TO 6 IN 12 REQUIRE BOTH PROROOING AND AIR-Z OR ENKAMAT (7008/7010) FLAT LOCK PANELS OVER A 6 IN 12 PITCH REQUIRE AIR-Z OR ENKAMAT (7008/7010) OR PROROOING.



Website: www.rheinzink.us E-mail: info@rheinzink.com

INFORMATION AND DETAILS HEREIN ARE ONLY A BASELINE FOR SYSTEM DESIGN AND INSTALLATION. MODIFICATION TO MEET PROJECT REQUIREMENTS IS THE RESPONSIBILITY OF THE DESIGNER AND ARCHITECT. RHEINZINK AMERICA STAFF ARE AVAILABLE TO ASSIST THE DESIGNER AND ARCHITECT IN THIS PROCESS. RHEINZINK AMERICA MAKES NO REPRESENTATIONS AND WARRANTIES OTHER THAN THOSE EXPRESSED HEREIN.

| | | | |
|---|------------------------------|--------|---------|
| PROJECT: | FLAT LOCK ROOF PANEL DETAILS | DATE: | 5-2020 |
| DRAWING TITLE: | VENT PIPE PENETRATION DETAIL | SCALE: | N.T.S. |
| COPYRIGHT RESERVED. THIS DRAWING REMAINS THE PROPERTY OF RHEINZINK. | | SHEET: | FLRP-13 |

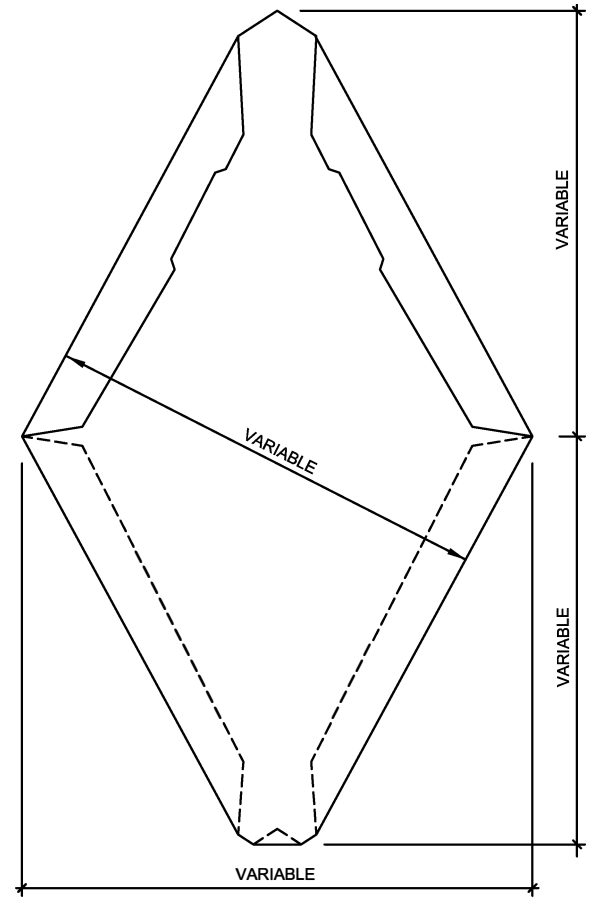
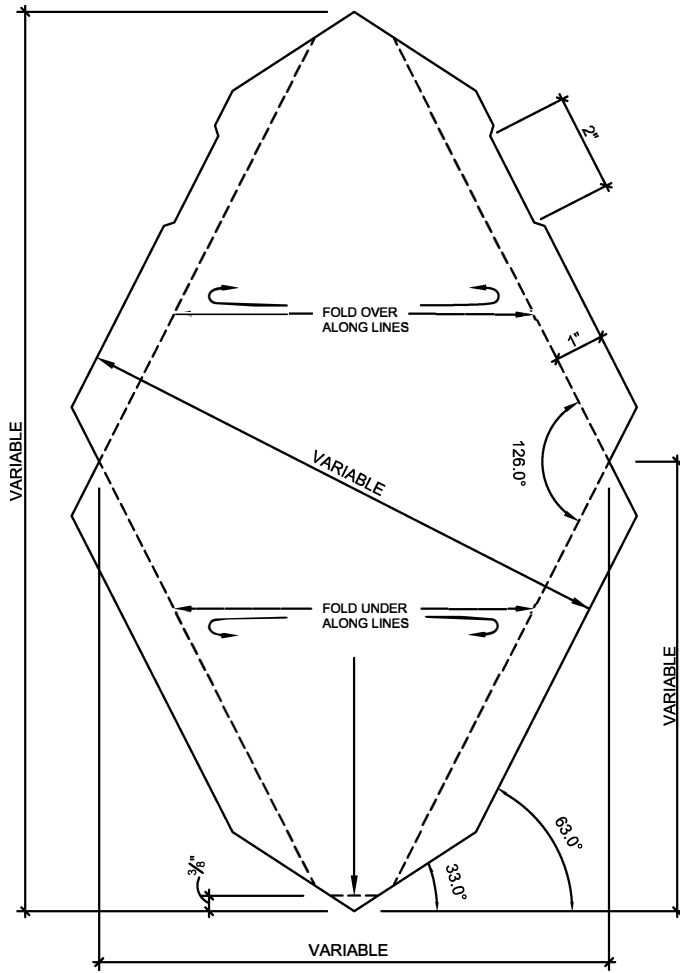

* CLIP DETAIL

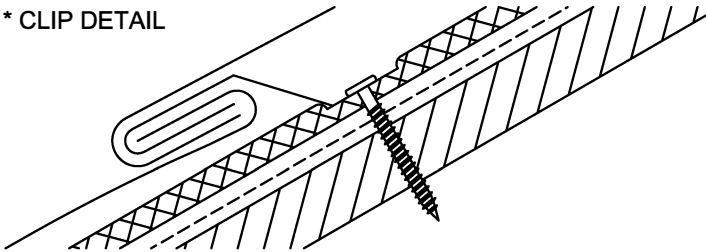

NOTES:

1. RHEINZINK RECOMMENDS STAINLESS STEEL FASTENERS AND CLIPS.
2. FLAT LOCK PANELS REQUIRE A MINIMUM OF 3:12 PITCH. FLAT LOCK PANEL ROOF SYSTEMS UP TO 6 IN 12 REQUIRE BOTH PROROOING AND AIR-Z OR ENKAMAT (7008/7010) FLAT LOCK PANELS OVER A 6 IN 12 PITCH REQUIRE AIR-Z OR ENKAMAT (7008/7010) OR PROROOING.



Website: www.rheinzink.us E-mail: info@rheinzink.com

INFORMATION AND DETAILS HEREIN ARE ONLY A BASELINE FOR SYSTEM DESIGN AND INSTALLATION. MODIFICATION TO MEET PROJECT REQUIREMENTS IS THE RESPONSIBILITY OF THE DESIGNER AND ARCHITECT. RHEINZINK AMERICA STAFF ARE AVAILABLE TO ASSIST THE DESIGNER AND ARCHITECT IN THIS PROCESS. RHEINZINK AMERICA MAKES NO REPRESENTATIONS AND WARRANTIES OTHER THAN THOSE EXPRESSED HEREIN.

| | | | |
|---|------------------------------|--------|---------|
| PROJECT: | FLAT LOCK ROOF PANEL DETAILS | DATE: | 5-2020 |
| DRAWING TITLE: | DIAMOND FABRICATION DETAIL | SCALE: | N.T.S. |
| COPYRIGHT RESERVED. THIS DRAWING REMAINS THE PROPERTY OF RHEINZINK. | | SHEET: | FLRP-14 |

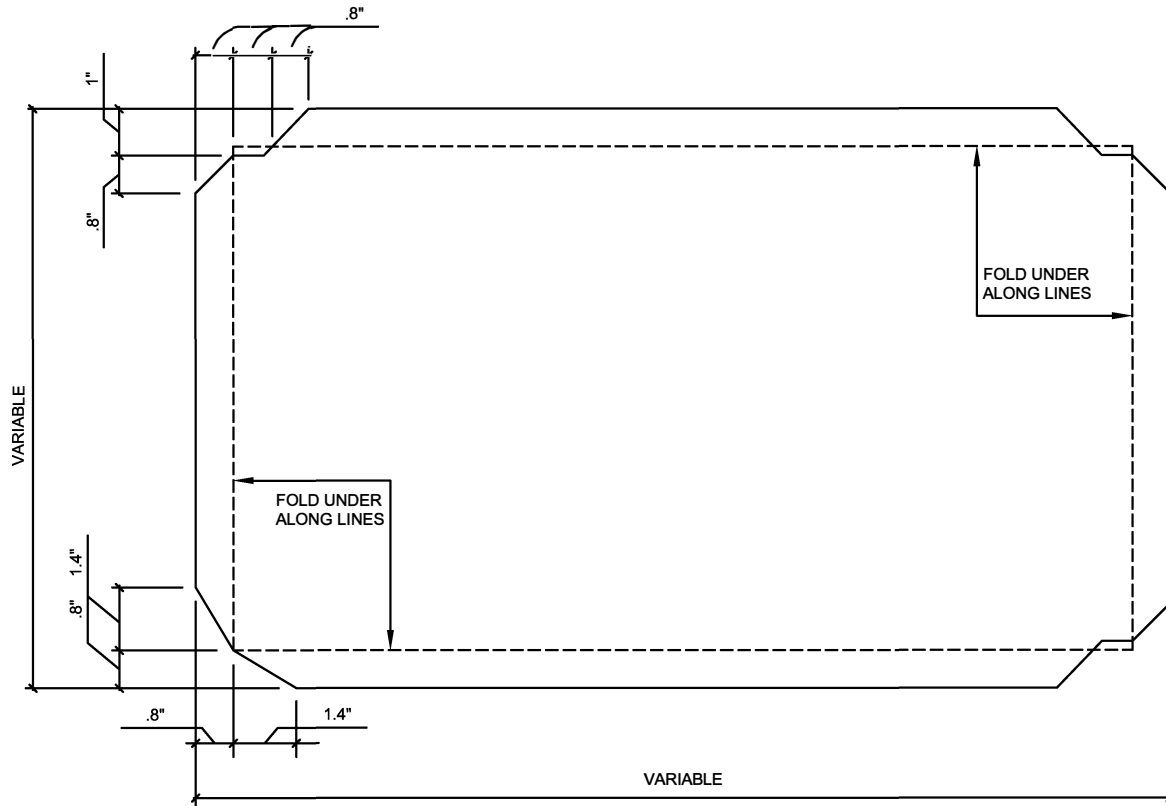

* CLIP DETAIL

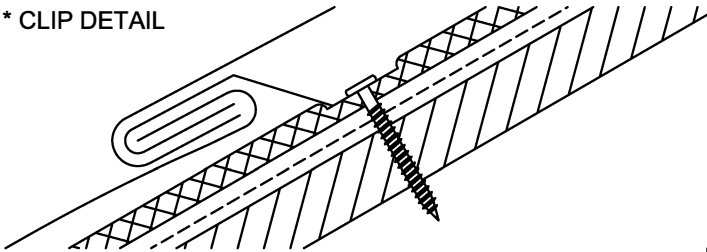

NOTES:

1. RHEINZINK RECOMMENDS STAINLESS STEEL FASTENERS AND CLIPS.
2. FLAT LOCK PANELS REQUIRE A MINIMUM OF 3:12 PITCH. FLAT LOCK PANEL ROOF SYSTEMS UP TO 6 IN 12 REQUIRE BOTH PROROOING AND AIR-Z OR ENKAMAT (7008/7010) FLAT LOCK PANELS OVER A 6 IN 12 PITCH REQUIRE AIR-Z OR ENKAMAT (7008/7010) OR PROROOING.



Website: www.rheinzink.us E-mail: info@rheinzink.com

INFORMATION AND DETAILS HEREIN ARE ONLY A BASELINE FOR SYSTEM DESIGN AND INSTALLATION. MODIFICATION TO MEET PROJECT REQUIREMENTS IS THE RESPONSIBILITY OF THE DESIGNER AND ARCHITECT. RHEINZINK AMERICA STAFF ARE AVAILABLE TO ASSIST THE DESIGNER AND ARCHITECT IN THIS PROCESS. RHEINZINK AMERICA MAKES NO REPRESENTATIONS AND WARRANTIES OTHER THAN THOSE EXPRESSED HEREIN.

| | | | |
|---|------------------------------|--------|----------|
| PROJECT: | FLAT LOCK ROOF PANEL DETAILS | DATE: | 5-2020 |
| DRAWING TITLE: | RECTANGULAR FAB DETAIL - H | SCALE: | N.T.S. |
| COPYRIGHT RESERVED. THIS DRAWING REMAINS THE PROPERTY OF RHEINZINK. | | SHEET: | FLRP-15A |

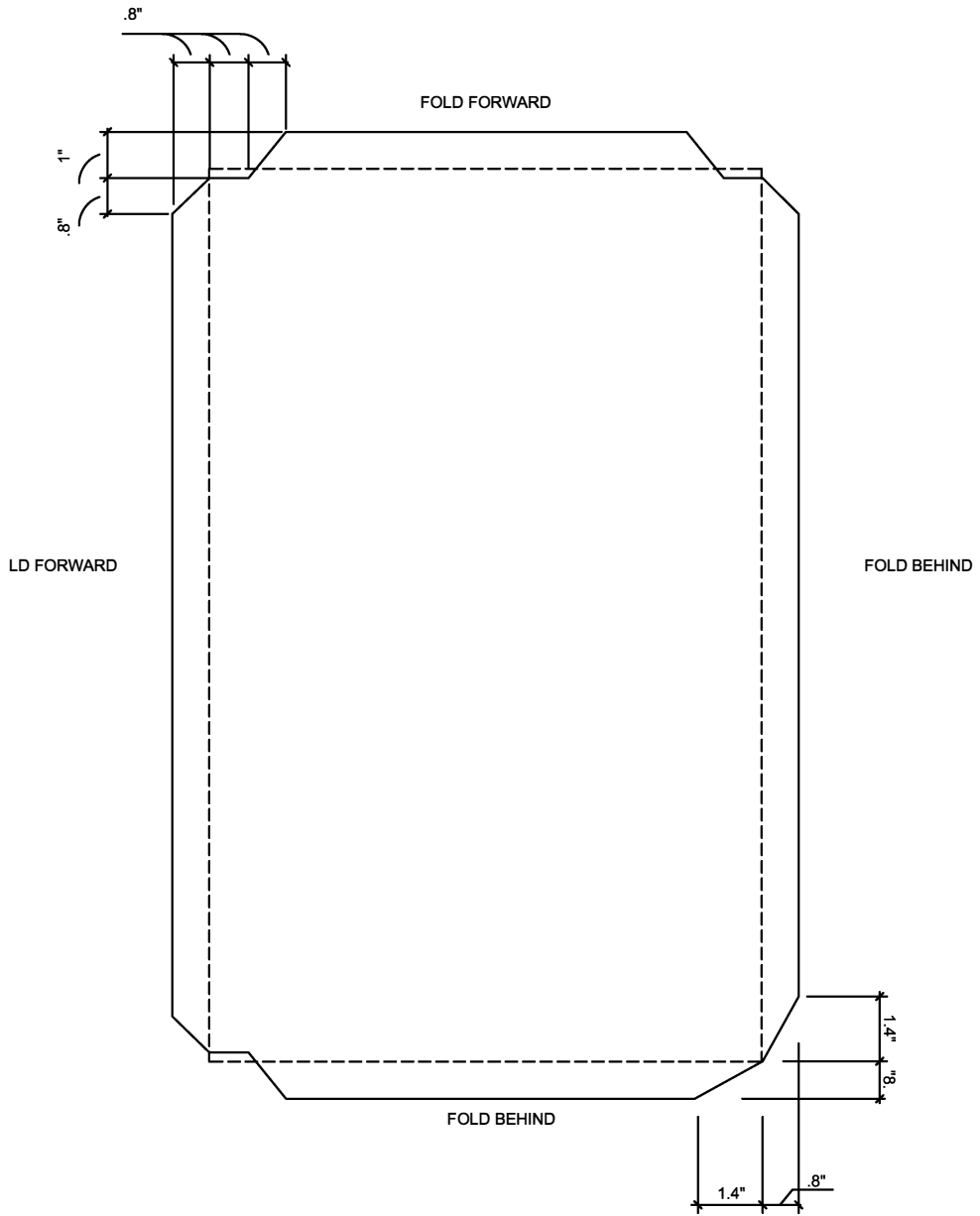

* CLIP DETAIL

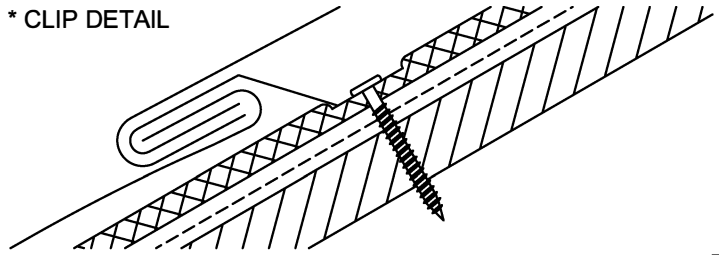

NOTES:

1. RHEINZINK RECOMMENDS STAINLESS STEEL FASTENERS AND CLIPS.
2. FLAT LOCK PANELS REQUIRE A MINIMUM OF 3:12 PITCH. FLAT LOCK PANEL ROOF SYSTEMS UP TO 6 IN 12 REQUIRE BOTH PROROOING AND AIR-Z OR ENKAMAT (7008/7010) FLAT LOCK PANELS OVER A 6 IN 12 PITCH REQUIRE AIR-Z OR ENKAMAT (7008/7010) OR PROROOING.

| | | |
|--|------------------------------|-----------------|
|  Website: www.rheinzink.us E-mail: info@rheinzink.com | | |
| INFORMATION AND DETAILS HEREIN ARE ONLY A BASELINE FOR SYSTEM DESIGN AND INSTALLATION. MODIFICATION TO MEET PROJECT REQUIREMENTS IS THE RESPONSIBILITY OF THE DESIGNER AND ARCHITECT. RHEINZINK AMERICA STAFF ARE AVAILABLE TO ASSIST THE DESIGNER AND ARCHITECT IN THIS PROCESS. RHEINZINK AMERICA MAKES NO REPRESENTATIONS AND WARRANTIES OTHER THAN THOSE EXPRESSED HEREIN. | | |
| PROJECT: | FLAT LOCK PANEL ROOF DETAILS | DATE: 5-2020 |
| DRAWING TITLE: | RECTANGULAR FAB DETAIL - V | SCALE: N.T.S. |
| COPYRIGHT RESERVED. THIS DRAWING REMAINS THE PROPERTY OF RHEINZINK. | | SHEET: FLRP-15B |

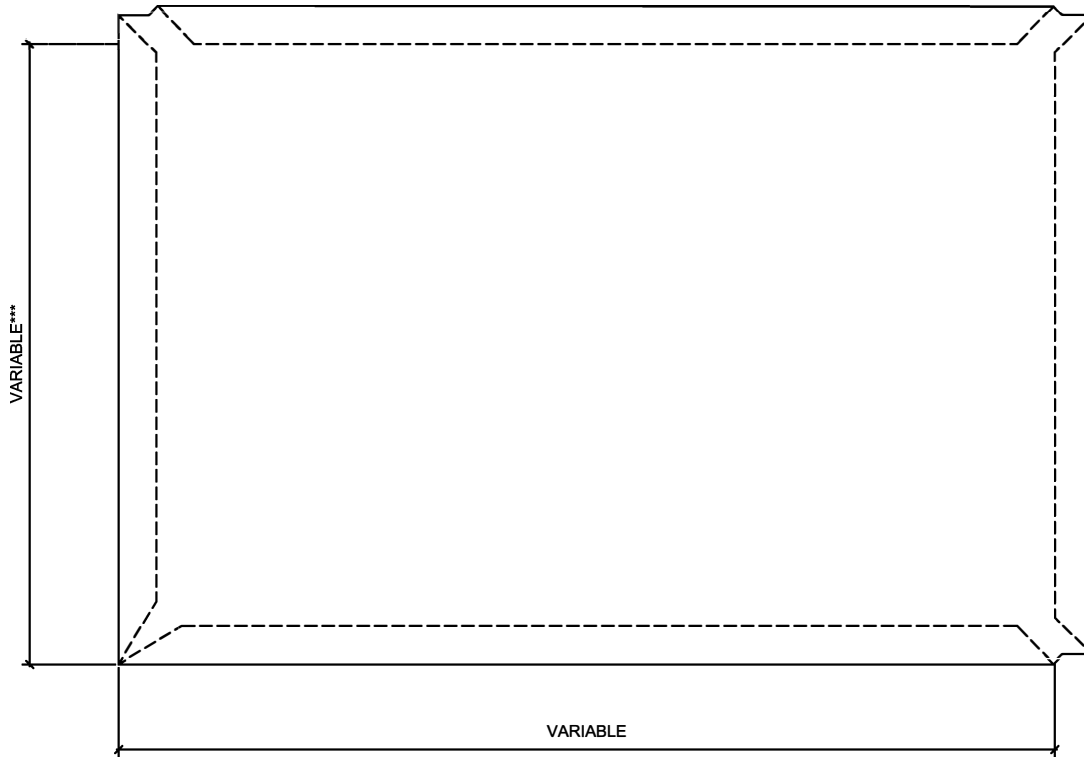

* CLIP DETAIL

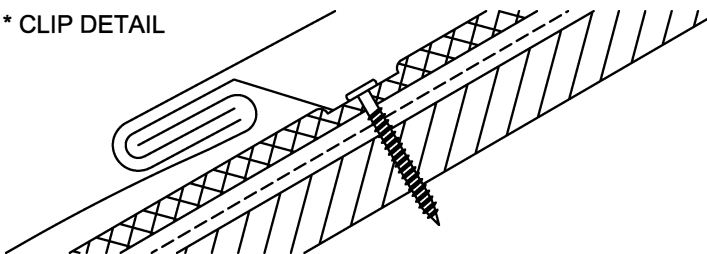

NOTES:

1. RHEINZINK RECOMMENDS STAINLESS STEEL FASTENERS AND CLIPS.
2. FLAT LOCK PANELS REQUIRE A MINIMUM OF 3:12 PITCH. FLAT LOCK PANEL ROOF SYSTEMS UP TO 6 IN 12 REQUIRE BOTH PROROOING AND AIR-Z OR ENKAMAT (7008/7010). FLAT LOCK PANELS OVER A 6 IN 12 PITCH REQUIRE AIR-Z OR ENKAMAT (7008/7010) OR PROROOING.
3. CLIP QUANTITY AND SPACING TO BE DETERMINED BY ENGINEERING CALCULATIONS

| | | |
|--|-------------------------------------|---------------------------|
|  Website: www.rheinzink.us E-mail: info@rheinzink.com | | |
| INFORMATION AND DETAILS HEREIN ARE ONLY A BASELINE FOR SYSTEM DESIGN AND INSTALLATION. MODIFICATION TO MEET PROJECT REQUIREMENTS IS THE RESPONSIBILITY OF THE DESIGNER AND ARCHITECT. RHEINZINK AMERICA STAFF ARE AVAILABLE TO ASSIST THE DESIGNER AND ARCHITECT IN THIS PROCESS. RHEINZINK AMERICA MAKES NO REPRESENTATIONS AND WARRANTIES OTHER THAN THOSE EXPRESSED HEREIN. | | |
| PROJECT: | FLAT LOCK ROOF PANEL DETAILS | DATE: 5-2020 |
| DRAWING TITLE: | RECT FAB DETAIL - H FOLDED | SCALE: N.T.S. |
| COPYRIGHT RESERVED. THIS DRAWING REMAINS THE PROPERTY OF RHEINZINK. | | SHEET: FLRP-15C |